



VATERRA™

GLAMIS UNO™

OWNER'S MANUAL

BEDIENUNGSANLEITUNG
MANUEL DE L'UTILISATEUR
MANUALE DELL'UTENTE

NOTICE

All instructions, warranties and other collateral documents are subject to change at the sole discretion of Horizon Hobby, Inc. For up-to-date product literature, visit www.horizonhobby.com and click on the support tab for this product.

MEANING OF SPECIAL LANGUAGE

The following terms are used throughout the product literature to indicate various levels of potential harm when operating this product:

NOTICE: Procedures, which if not properly followed, create a possibility of physical property damage AND a little or no possibility of injury.

CAUTION: Procedures, which if not properly followed, create the probability of physical property damage AND a possibility of serious injury.

WARNING: Procedures, which if not properly followed, create the probability of property damage, collateral damage, and serious injury OR create a high probability of superficial injury.



WARNING: Read the ENTIRE instruction manual to become familiar with the features of the product before operating. Failure to operate the product correctly can result in damage to the product, personal property and cause serious injury.

This is a sophisticated hobby product and NOT a toy. It must be operated with caution and common sense and requires some basic mechanical ability. Failure to operate this Product in a safe and responsible manner could result in injury or damage to the product or other property. This product is not intended for use by children without direct adult supervision. Do not attempt disassembly, use with incompatible components or augment product in any way without the approval of Horizon Hobby, Inc. This manual contains instructions for safety, operation and maintenance. It is essential to read and follow all the instructions and warnings in the manual, prior to assembly, setup or use, in order to operate correctly and avoid damage or serious injury.

**AGE RECOMMENDATION: Not for children under 14 years.
This is not a toy.**

REGISTER YOUR VATERRA PRODUCT ONLINE

Register your vehicle now and be the first to find out about the latest option parts, product updates and more. Click on the Support tab at WWW.VATERRARC.COM and follow the product registration link to stay connected.

SAFETY PRECAUTIONS AND GUIDELINES

- » Always keep a safe distance in all directions around your model to avoid collisions or injury. This model is controlled by a radio signal subject to interference from many sources outside your control. Interference can cause momentary loss of control.
- » Always operate your model in open spaces away from full-size vehicles, traffic and people.
- » Always carefully follow the directions and warnings for this and any optional support equipment (chargers, rechargeable battery packs, etc.).
- » Always keep all chemicals, small parts and anything electrical out of the reach of children.
- » Always avoid water exposure to all equipment not specifically designed and protected for this purpose. Moisture causes damage to electronics.
- » Never place any portion of the model in your mouth as it could cause serious injury.
- » Never operate your model with low transmitter batteries.

WATER-RESISTANT VEHICLE WITH WATERPROOF ELECTRONICS //////////////////////////////////////

Your new Horizon Hobby vehicle has been designed and built with a combination of waterproof and water-resistant components to allow you to operate the product in many “wet conditions”, including puddles, creeks, wet grass, snow and even rain.

While the entire vehicle is highly water-resistant, it is not completely waterproof and your vehicle should NOT be treated like a submarine. The various electronic components used in the vehicle, such as the Electronic Speed Control (ESC), servo(s) and receiver are waterproof, however, most of the mechanical components are water-resistant and should not be submerged.

Metal parts, including the bearings, hinge pins, screws and nuts, as well as the contacts in the electrical cables, will be susceptible to corrosion if additional maintenance is not performed after running in wet conditions. To maximize the long-term performance of your vehicle and to keep the warranty intact, the procedures described in the “Wet Conditions Maintenance” section to follow must be performed regularly if you choose to run in wet conditions. If you are not willing to perform the additional care and maintenance required, then you should not operate the vehicle in those conditions.



CAUTION: Failure to exercise caution while using this product and complying with the following precautions could result in product malfunction and/or void the warranty.

GENERAL PRECAUTIONS

- » Read through the wet conditions maintenance procedures and make sure that you have all the tools you will need to properly maintain your vehicle.
- » Not all batteries can be used in wet conditions. Consult the battery manufacturer before use. Do not use Li-Po batteries in wet conditions.
- » Most transmitters are not water-resistant. Consult your transmitter’s manual or the manufacturer before operation.
- » Never operate your transmitter or vehicle where lightning may be present.
- » Do not operate your vehicle where it could come in contact with salt water (ocean water or water on salt-covered roads), contaminated or polluted water. Salt water is very conductive and highly corrosive, so use caution.
- » Even minimal water contact can reduce the life of your motor if it has not been certified as water-resistant or waterproof. If the motor becomes excessively wet, apply very light throttle until the water is mostly removed from the motor. Running a wet motor at high speeds may rapidly damage the motor.
- » Driving in wet conditions can reduce the life of the motor. The additional resistance of operating in water causes excess strain. Alter the gear ratio by using a smaller pinion or larger spur gear. This will increase torque (and motor life) when running in mud, deeper puddles, or any wet conditions that will increase the load on the motor for an extended period of time.

WET CONDITIONS MAINTENANCE

- » Remove the battery pack(s) and dry the contacts. If you have an air compressor or a can of compressed air, blow out any water that may be inside the recessed connector housing.
- » Remove the tires/wheels from the vehicle and gently rinse the mud and dirt off with a garden hose. Avoid rinsing the bearings and transmission.

NOTICE: Never use a pressure washer to clean your vehicle.

- » Use an air compressor or a can of compressed air to dry the vehicle and help remove any water that may have gotten into small crevices or corners.
- » Spray the bearings, drive train, fasteners and other metal parts with WD-40® solvent or any other water-displacing light oil. Do not spray the motor.
- » Let the vehicle air dry before you store it. Water (and oil) may continue to drip for a few hours.
- » Increase the frequency of disassembly, inspection and lubrication of the following:
 - Front and rear axle hub assembly bearings.
 - All transmission cases, gears and differentials.
 - Motor—clean with an aerosol motor cleaner and re-oil the bearings with lightweight motor oil.

INTRODUCTION

Thank you for purchasing the Vatera™ 1/8-Scale Glamis Uno™ Single Seat RTR Buggy. This guide contains the basic instructions for operating your new Glamis Uno Single Seat Buggy. It is critical that you read all of the instructions in order to operate your model correctly and avoid unnecessary damage.

4 Introduction
4 Quick Start
5 Components
7 The Vehicle Battery
9 The Transmitter
9 Transmitter and Receiver Binding
10 Control Test
10 Before Running Your Vehicle
11 Run Time
11 Tuning, Adjusting & Maintaining Your Vehicle
13 Dynamite 70A Waterproof Sensorless Brushless ESC
14 Dynamite Fuze 540 4-Pole 3300Kv Sensorless Brushless Motor
15 Troubleshooting Guide
17 Limited Warranty
18 FCC statement
18 Compliance Information for the European Union
70 Fasteners
71 Replacement parts/Exploded Views
91 Optional Parts

Please read the entire manual to gain a full understanding of the Glamis Uno vehicle, fine-tuning the setup and performing maintenance..

1. Read the safety precautions found in this manual.
2. Charge the battery. Refer to the included charging warnings and instructions for battery charging information.
3. Install the AA batteries in the transmitter. Only use alkaline or rechargeable batteries.
4. Install the fully charged battery in the vehicle.
5. Power ON the transmitter and then the vehicle. Always power the transmitter ON before the vehicle and power it OFF after the vehicle has been powered OFF.
6. Check the steering and throttle control directions. Verify that the servos are moving in the correct direction.
7. Drive your vehicle.
8. Perform any necessary maintenance.

COMPONENTS

- » 1/8-Scale Glamis Uno Single Seat RTR Buggy
- » Spektrum™ DX2L 2.4GHz DSM® Radio System
- » Dynamite® Fuze™ 70A Waterproof Sensorless Brushless ESC
- » Dynamite Fuze 540 4-Pole 3300Kv Sensorless Brushless Motor
- » 113WP Standard Waterproof Servo
- » Dynamite Speedpack™ Silver 2S 7.4V 3000mAh 20C Li-Po Battery
- » Dynamite 10W Li-Po AC Balance Charger
- » 4 AA batteries (for transmitter)

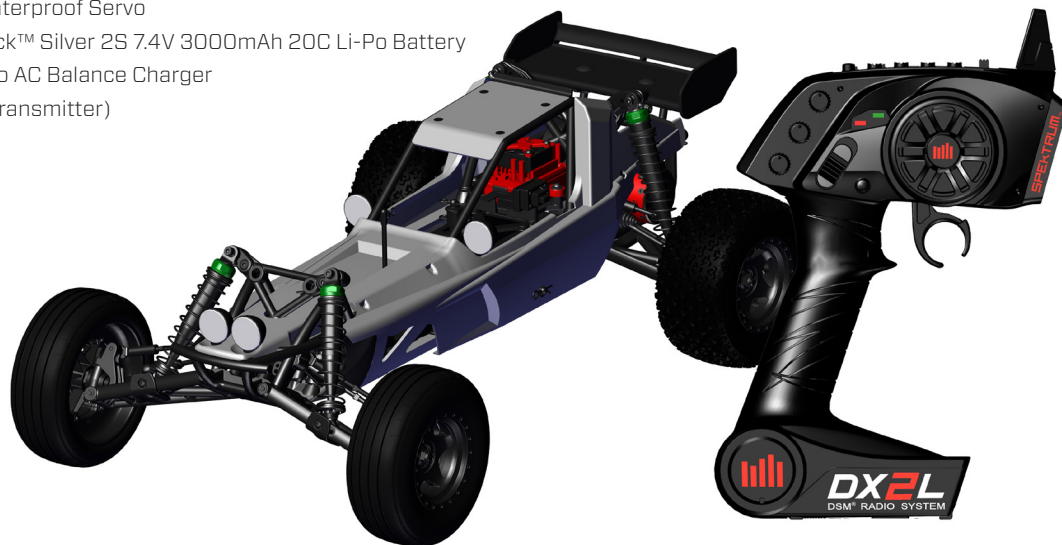

RECOMMENDED ACCESSORIES

- » Hobby grade knife
- » Needle nose pliers
- » Side cutting pliers
- » Safety goggles
- » Soldering iron

Use only Dynamite tools or other high-quality tools. Use of inexpensive tools can cause damage to the small screws and parts used on this type of model.

SUPPLIED TOOLS

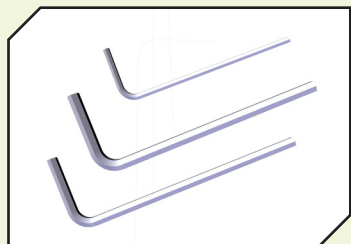

- » "L" shaped hex wrench
 - 1.5mm, 2mm, 2.5mm



- » 4-way wrench

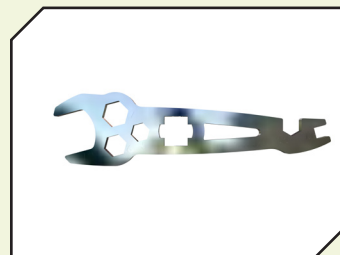

- » Flat Turnbuckle Wrench



- » Shock Tools

THE VEHICLE BATTERY

Refer to the charging warnings. It is recommended you charge the battery while you inspect the vehicle. The battery will be required to confirm proper operation in future steps.

Charge only batteries that are cool to the touch and are not damaged. Inspect the battery to make sure it is not damaged, e.g., swollen, bent, broken or punctured.

WARNING: Failure to exercise caution while using this product and comply with the following warnings could result in product malfunction, electrical issues, excessive heat, FIRE, and ultimately injury and property damage.

CAUTION: Always disconnect a Li-Po battery from the charger to avoid over-discharging the battery. Batteries discharged to a voltage lower than the lowest approved voltage may become damaged, resulting in loss of performance and potential fire when batteries are charged.

CAUTION: Never exceed the recommended charge rate.

Failure to follow these procedures can cause damage to batteries, personal property or cause serious injury.

CHARGING WARNINGS

- » Never leave the charger and battery unattended during use.
- » Never attempt to charge dead, damaged or wet battery packs.
- » Never attempt to charge a battery pack containing different types of batteries.
- » Never allow minors to charge battery packs.
- » Never charge batteries in extremely hot or cold places or place in direct sunlight.
- » Never charge a battery if the cable has been pinched or shorted.
- » Never connect more than one battery pack to this charger at a time.
- » Never connect the charger if the power cable has been pinched or shorted.
- » Never attempt to dismantle the charger or use a damaged charger.
- » Never reverse the positive and negative terminals.
- » Always use only rechargeable batteries designed for use with this type of charger.
- » Always inspect the battery before charging.
- » Always keep the battery away from any material that could be affected by heat.
- » Always monitor the charging area and have a fire extinguisher available at all times.
- » Always end the charging process if the battery becomes hot to the touch or starts to change form (swell) during the charge process.
- » Always disconnect the battery after charging, and let the charger cool between charges.
- » Always terminate all processes and contact Horizon Hobby if the product malfunctions.

CHARGING THE BATTERY

- A Cell 1 LED
- B Cell 2 LED
- C Cell 3 LED
- D AC Power Slot
- E 2S Charge Port
- F 3S Charge Port

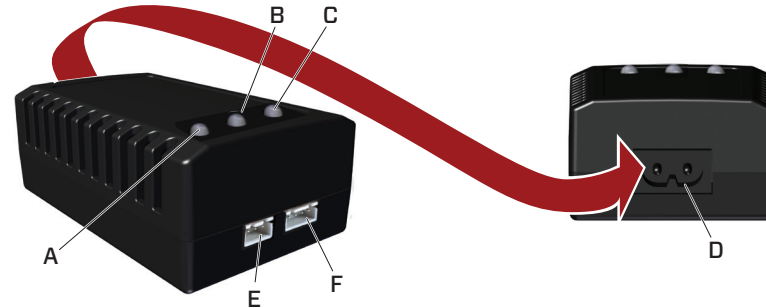

- 1 Connect the AC power cord to the power slot on the charger, then connect the other end of the power cord to an AC power source.
- 2 The three LEDs will turn green when the charger is connected to the AC power source.
- 3 Connect the balance connector of the battery to the proper charge port on the charger (the 3S charge port has 4 pins and the 2S charge port has 3 pins).
- 4 The three LEDs will turn red, indicating the battery is charging.
- 5 When the charging of one cell is complete, the corresponding LED turns green.
- 6 Once the battery pack is fully charged, all three LEDs will turn green.
- 7 Disconnect the battery from the charger.
- 8 Disconnect the AC power cord from the AC power source.

INSTALLING THE VEHICLE BATTERY

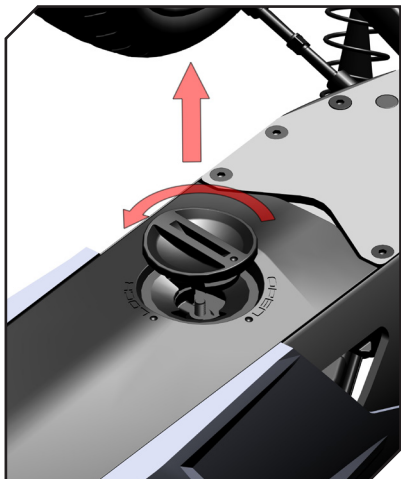

- 1 Ensure the ESC is powered OFF.
- 2 Turn the vehicle over so the bottom faces up.
- 3 Turn the battery door lock counter-clockwise, then pull it out.

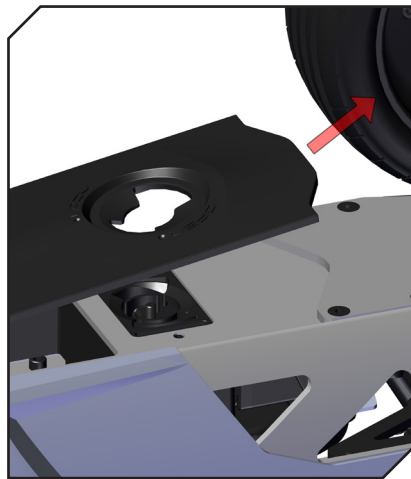

- 4 Lift the front end of the battery door, then pull it forward.
- 5 Install the fully charged battery in the battery cavity.
- 6 Connect the battery to the ESC.

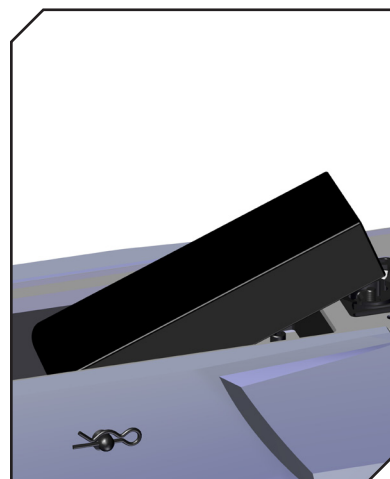

- 7 Reinstall the battery door and lock.
- 8 Power ON the transmitter, then the vehicle.

⚠ CAUTION: If at any time batteries become damaged, hot, or begin to balloon or swell, discontinue charging (or discharging) immediately. Quickly and safely disconnect the charger. DO NOT continue to handle, attempt to use, or ship the batteries.

⚠ WARNING: Never leave charger unattended, exceed maximum charge rate, charge with non-approved batteries or charge batteries in the wrong mode. Failure to comply may result in excessive heat, fire and serious injury.

⚠ CAUTION: Always ensure the battery you are charging meets the specifications of this charger and that the charger settings are correct. Not doing so can result in excessive heat and other related product malfunctions, which can lead to user injury or property damage. Please contact Horizon Hobby or an authorized retailer with compatibility questions.

The vehicle battery charger produces 1350 milliAmps per hour. Divide the mAh capacity on the label of a battery by 1350 to know how long battery charging will require. For example, a 2S 3000mAh battery requires 2.2 hours to charge

THE TRANSMITTER

For more information on the transmitter, go to www.horizonhobby.com and click on the support tab for the Spektrum DX2L to download the instruction manual.

CHANGING THE RF MODE

The DX2L has a France RF Mode that complies with French regulations. The DX2L must be in France mode when used outdoors in France. At all other times, the transmitter should be in Standard mode.

France mode ON

Turn the wheel full left, pull the trigger full throttle and hold down the bind button while turning on the transmitter. The red LED will flash twice.

France mode OFF (Standard Mode)

Turn the wheel full right, pull the trigger full throttle and hold down the bind button while turning on the transmitter. The red LED will flash once.

SPEKTRUM DX2L RADIO SYSTEM

- 1 Steering Wheel** controls direction (left/right) of the model
- 2 Throttle Trigger** controls speed and direction (forward/brake/reverse) of the model
- 3 R.O.S.S. Button** used with vehicles featuring the R.O.S.S. Remote Start System
- 4 Antenna** transmits the signal to the model
- 5 ON/OFF Switch** turns the power ON/OFF for the transmitter
- 6 Indicator Lights**
 - *Solid green (right) light* indicates adequate battery power
 - *Flashing green light* indicates the battery voltage is critically low. Replace batteries.
 - *Solid red (left) light* indicates good signal strength. When the red light fades, signal strength is weakening
- 7 ST. Trim** adjusts the “hands off” direction of the model
- 8 TH. Trim** adjusts the motor speed to stop at neutral
- 9 Steering Dual Rate** adjusts the amount the front wheels move when the steering wheel is turned left and right
- 10 Battery Cover** covers and holds the batteries that power the transmitter
- 11 BIND Button** puts the transmitter into Bind Mode
- 12 ST. REV** reverses the function of the steering when the wheel is turned left or right
- 13 TH. REV** reverses the function of the speed control when pulled back or pushed forward
- 14 TH-F – Forward Endpoint** – Adjusts the amount of full throttle
- 15 TH-B – Brake Endpoint** – Adjusts the amount of full brake
- 16 ST-L – Steering Left Endpoint** – Adjusts the amount of left steering travel
- 17 ST-R – Steering Right Endpoint** – Adjusts the amount of right steering travel
- 18 Throttle Limiter** limits the throttle to Low (50%), Medium (75%) or High (full throttle is equal to the high Throttle Travel position)
- 19 Bind Plug Compartment**

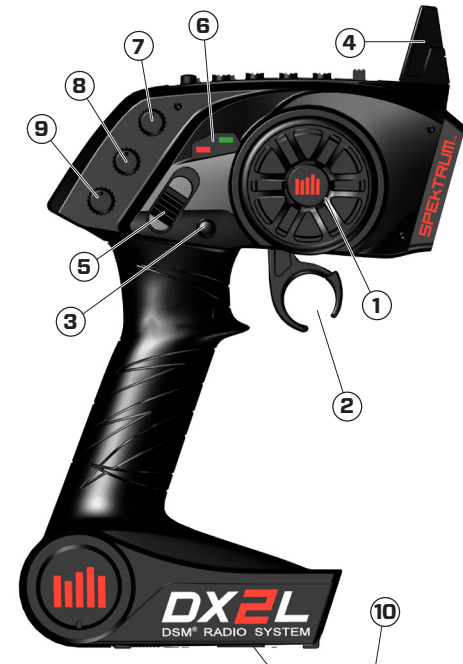
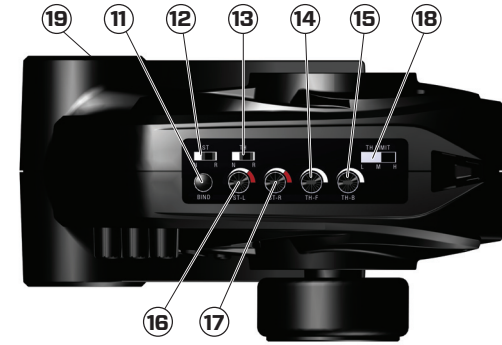

INSTALLING THE TRANSMITTER BATTERIES

- 1 Push in the battery cover a small amount to release the retaining tab, then remove the cover.
- 2 Install 4 AA batteries, taking care to align the battery polarity to the diagram in the transmitter's battery case.
- 3 Carefully reinstall the battery cover by aligning the tabs with the slots on the transmitter.

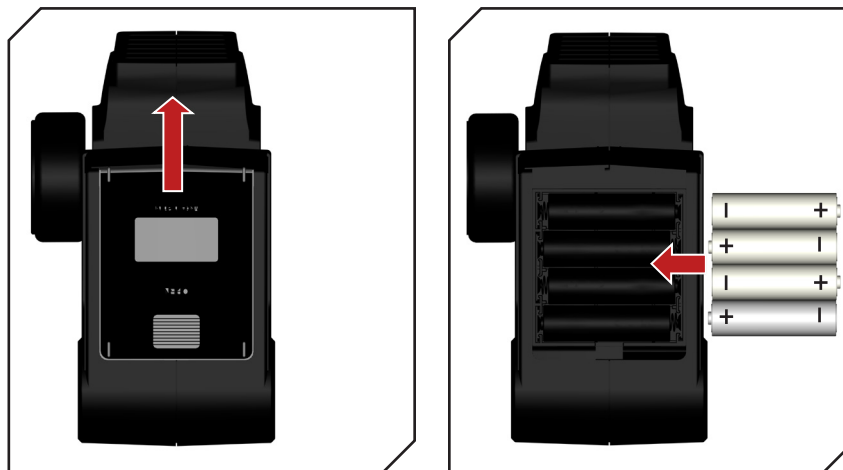

CAUTION: NEVER remove the transmitter batteries while the vehicle is powered ON, as loss of control, property damage or injury may result.

TRANSMITTER AND RECEIVER BINDING

BINDING PROCEDURE

- 1 Make sure the transmitter and vehicle are both powered OFF.
- 2 Install a bind plug in the receiver battery/bind port. You do not need to remove any of the other plugs to re-bind.
- 3 With the bind plug installed, power ON the vehicle. The receiver LED will flash green.
- 4 With the steering and throttle in the desired preset failsafe positions (neutral), press and hold the bind button and power ON the transmitter. The transmitter's red LED will flash after 4 seconds when the transmitter is in bind mode. Release the bind button once the red LED flashes. Continue holding the failsafe positions until the binding process is complete.
- 5 When the receiver binds to the transmitter, the receiver LED will turn solid.
- 6 Power OFF the vehicle, then the transmitter.
- 7 Disconnect the battery from the ESC. Remove the bind plug from the receiver.
- 8 Safely store the bind plug in the bind plug compartment in the transmitter.
- 9 The receiver will keep the binding to the transmitter until another binding is done.

Your Spektrum DX2L comes prebound to the vehicle.

If you encounter problems, obey binding instructions and refer to the transmitter troubleshooting guide for other instructions. If needed, contact the appropriate Horizon Product Support office.

CONTROL TEST

Perform a control test with the vehicle wheels off the ground. If the wheels rotate after the vehicle is powered ON, adjust the “TH. Trim” knob until they stop. To make the wheels move forward, pull the trigger. To reverse them, wait for the wheels to stop, then push the trigger. When moving forward, the wheels should maintain a straight line without any steering wheel input. If not, adjust the “ST. Trim” knob, so the wheels maintain a straight line without having to turn the steering wheel.

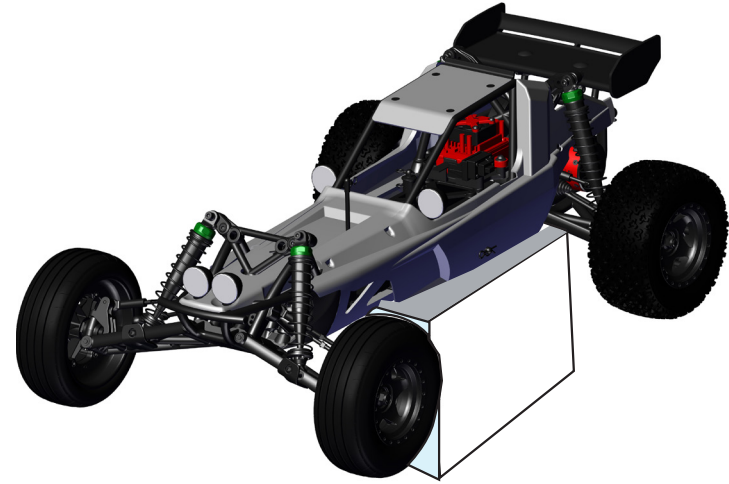

BEFORE RUNNING YOUR VEHICLE

⚠ CAUTION: Do not discharge a Li-Po battery below 3V per cell. Batteries discharged to a voltage lower than the lowest approved voltage may become damaged, resulting in loss of performance and potential fire when batteries are charged.

- 1 Break in the differential. While holding the chassis with only the left rear tire firmly on the ground, give the vehicle about 1/8 throttle for 30 seconds. The right rear tire should spin freely during this time. Do this with only the right rear tire firmly on the ground, allowing the left to spin freely. Repeat this 2-3 times.
- 2 Check for free suspension movement. All suspension arms and steering components should move freely. Any binds will cause the vehicle to handle poorly.
- 3 Charge the battery.
- 4 Check the calibration of the ESC. If recalibration is required, follow the setup instructions.
- 5 Adjust the transmitter settings to your desired configuration.

RUN TIME

TO IMPROVE RUN TIMES

- » Clean and oil bearings often. If bearings are dirty, they will increase friction and cause reduced performance.
- » Keep your vehicle clean and maintained.
- » Allow more airflow to the ESC and motor.
- » Change the gearing to a lower ratio. A lower ratio decreases the operating temperature of the electronics. Use a smaller pinion gear or larger spur gear to lower the gear ratio.
- » Use a battery pack with a higher mAh rating.

DRIVING PRECAUTIONS

- » Maintain sight of the vehicle at all times.
- » Routinely inspect the vehicle for loose wheel hardware.
- » Routinely inspect the steering assembly for any loose hardware. Driving the vehicle off-road can cause fasteners to loosen over time.
- » Do not drive the vehicle in tall grass. Doing so can damage the vehicle or electronics.
- » Stop driving the vehicle when you notice a lack of power. Driving the vehicle when the battery is discharged can cause the receiver to power off. If the receiver loses power, you will lose control of the vehicle. Damage due to an over-discharged battery is not covered under warranty.
- » Do not apply forward or reverse throttle if the vehicle is stuck. Applying throttle in this instance can damage the motor or ESC.
- » After driving the vehicle, allow the electronics to cool before driving the vehicle again. Remove the body of the vehicle to reduce cooling time.

The largest factor in run time is the capacity of the battery pack. A larger mAh rating increases the amount of run time experienced.

The condition of a battery pack is also an important factor in both run time and speed. The battery connectors may become hot during driving. Batteries will lose performance and capacity over time.

Driving the vehicle from a stop to full speed repeatedly will damage the batteries and electronics over time. Sudden acceleration will also lead to shorter run times.

TUNING, ADJUSTING & MAINTAINING YOUR VEHICLE

- » Examine your vehicle on a regular basis.
- » Use a brush to remove dirt and dust.
- » Look for damage to the suspension arms and other molded parts.
- » Re-glue the tires to the wheels, if necessary.
- » Clean and oil all wheel bearings.
- » Use suitable tools to tighten fasteners.
- » Make sure the camber and steering linkages are not bent. Replace any bent linkages.
- » Adjust the Toe and Camber settings, if necessary.
- » Remove the shocks and inspect them for damage. Rebuild the shocks if oil is leaking.
- » Inspect the electronics and batteries for exposed wires. Repair exposed wires with shrink-wrap, or replace the wire.
- » Make sure the ESC and receiver are secure on the chassis. Replace the double-sided tape, if necessary.
- » Power ON the transmitter. If the green LED is dim or off, replace the AA batteries in your transmitter.
- » Check the spur gear and pinion gear for wear.

SERVICE/REPAIR

If any problems other than those covered in this manual arise, please refer to the Warranty and Service Information to contact your nearest Horizon Product Support office.

CLEANING

Performance can be hindered if dirt gets in any of the moving suspension parts. Use compressed air, a soft paintbrush or a toothbrush to remove dust or dirt. Avoid using solvents or chemicals, as they can actually wash dirt into the bearings or moving parts, as well as cause damage to the electronics.

TECHNICAL SPECIFICATIONS

Type	Sensorless/ Waterproof
Constant/Peak	70A/290A
Resistance	0.0012 Ohm
Function	Forward Only with Brake Forward/Reverse with Brake
Operation	Proportional forward, proportional reverse with braking delay
Battery Type/ Input Voltage	2-3 cell Li-Po/Li-Fe or 4-9 cell Ni-MH/Ni-Cd
BEC output	6V/3A
Overload Protection	Thermal
Dimensions (LxWxH)	31.5mm x 27.5mm x 33mm (1.24 in x 1.08 in x 1.30 in)
Weight	74 g (2.61 oz) with wires

ESC LED STATUS

- » No ESC LEDs will glow when there is no throttle input from the transmitter
- » The red ESC LED glows when there is any throttle input from the transmitter

AUDIBLE WARNING TONES

- 1** Input voltage: The ESC checks the input voltage when it is powered ON. If a voltage problem is detected, the ESC continuously sounds 2 beeps with a 1 second pause (xx-xx-xx). Power OFF the ESC and ensure the connections are secure and that the battery power is not too low for safe operation.
- 2** Radio connection: The ESC checks radio signal input when it is powered ON. If a problem is detected, the ESC continuously sounds 1 beep with a 2 second pause (x--x--x). Power OFF the ESC and ensure the radio system is operating correctly.

NOTICE: Always disconnect the battery from the ESC when you have finished operating your vehicle. The ESC's switch only controls power to the receiver and servos. The ESC will continue to draw current when connected to the battery, resulting in possible damage to the battery through over-discharge.

ESC CALIBRATION PROCEDURE

Ensure proper ESC function by calibrating the ESC to your transmitter inputs.

- 1** Power OFF the ESC.
- 2** Ensure your transmitter is powered ON, the throttle is not reversed, the throttle trim is neutral and the throttle travel range is at 100%.
- 3** Press the SET button while powering ON the ESC. Release the button as soon as the green LED starts to flash.
- 4** Calibrate the throttle points by pressing the SET button once after each step.
 - Neutral (1 flash)—leave the throttle at rest, untouched
 - Full throttle (2 flashes)—pull the throttle fully back
 - Full brake/reverse (3 flashes)—push the throttle fully forward
- 5** The motor vibrates for 3 seconds after the last step is completed.

ESC FUNCTIONS AND MODES

The ESC includes programming options so you can adjust the way your vehicle performs. Refer to the included settings table to adjust the ESC for your driving conditions.

ESC PROGRAMMING PROCEDURE

Programming is accomplished using the SET button on the ON/OFF switch.

PROGRAMMING THE ESC:

- 1** Connect a fully charged battery to the ESC.
- 2** Power ON the ESC.
- 3** Hold the SET button for 1 second until the green LED blinks, then release the SET button to enter programming mode.
- 4** Press and release the SET button as needed to get to the desired menu option (the Green LED will blink corresponding to the menu item number).
- 5** When at the desired menu item, hold the SET button for 3 seconds until the red LED blinks.
- 6** Press the SET button to move among the settings based on how many times the red LED blinks (Refer to the table for more information).
- 7** Save the setting by holding the SET button for 3 seconds.
- 8** Power OFF the ESC and repeat the instructions above to change other settings.

Tip: If desired, the ESC programming can be returned to default settings by powering ON the ESC and holding the SET button for 5 seconds.

PROGRAMMABLE VALUE

DEFAULT SETTINGS

PROGRAMMABLE ITEMS	1	2	3	4	5	6	7	8
1 Running Mode	Forward Only with Brake	Forward/Reverse with Brake						
2 Drag Brake Force	0%	5%	10%	15%	20%	25%	30%	40%
3 Low Voltage Cutoff Threshold	non-protection	2.6V/Cell	2.8V/Cell	3.0V/Cell	3.2V/Cell	3.4V/Cell		
4 Start Mode (Punch)	Level 1	Level 2	Level 3	Level 4				
5 Max Brake Force	25%	50%	75%	100%				

DESCRIPTIONS

1 RUNNING MODE

» **Forward Only with Brake**

Intended for competition use, this mode allows only forward and brake controls.

» **Forward/Reverse with Brake**

This mode is the basic all-around mode, allowing forward, reverse and brake controls. To engage reverse while moving forward, apply the brake until the vehicle has come to stop. Release the brake, then apply the brake again. While braking or in reverse, engaging the throttle will result in the vehicle immediately accelerating forward.

2 DRAG BRAKE FORCE

Adjusts the amount of brake automatically applied when the throttle is returned to neutral. This simulates the

engine braking effect of a full-scale vehicle, allowing improved turn-in and your vehicle's general response to controls.

3 LOW VOLTAGE CUTOFF THRESHOLD

This function helps to prevent battery over-discharge. The ESC continuously monitors the battery's voltage. If the voltage falls below the voltage threshold for 2 seconds, the output power shuts off and the red LED flashes twice repeatedly.

The cutoff threshold calculation is based on individual Li-Po cell voltage. For Ni-MH batteries, if the voltage battery pack is higher than 9.0V, it will be treated as a 3-cell Li-Po battery pack; if it is lower than 9.0V, it will be treated as a 2-cell Li-Po battery pack. Example: for a 8.0V Ni-MH battery pack used with a 2.6V/cell threshold, it will be treated as a 2-cell

Li-Po battery pack and the low-voltage cutoff threshold will be 5.2V (2.6x2=5.2). Using the optional Digital Program Box (DYN3748), you can adjust the custom values for the cutoff threshold. Unlike the preset values, custom cutoff values are for the total battery voltage, not individual cell voltage.

4 START MODE (PUNCH)

Sets the initial throttle punch when the car accelerates. Level 1 gives a very soft initial acceleration and level 4 gives a stronger initial acceleration.

5 MAX BRAKE FORCE

Adjusts the maximum braking force. A higher value provides stronger braking, but can also cause the wheels to lock, resulting in loss of control of the car.

PRECAUTIONS

- » Never touch moving parts.
- » Never disassemble while the batteries are installed.
- » Always let parts cool before touching.

GEAR CHART

Pinion/ Battery	FINAL DRIVE RATIO	
	2S	3S
19T	12.18	12.18
20T	11.57	11.57
21T	11.02	11.02
22T	10.52	10.52
23T	10.06	10.06
24T	9.64	9.64
25T	9.26	9.26
26T	8.9	8.9
27T	8.57	8.57

Marginal	THERMO	OK
----------	--------	----

EXAMPLE

INTERNAL GEAR RATIO	2.66
SPUR	87
PINION	20
FINAL DRIVE RATIO	11.571

ADJUSTING THE SLIPPER

Turn the 4mm adjustment nut clockwise (to the right) to reduce the slip or counterclockwise (to the left) to increase the slip.

GEARING

Your vehicle has been equipped with the optimal gearing for the stock platform. It offers an ideal balance between speed, power and efficiency. Should you decide to customize your vehicle with optional batteries or motors, it may be necessary for you to change the pinion or spur gear.

Installing a pinion gear with less teeth or a spur gear with more teeth will provide greater torque but will reduce top speed. Likewise, a pinion gear with more teeth or a spur gear with fewer teeth will reduce torque and increase top speed. Care should be taken when installing larger pinion gears as this can “overgear” the vehicle, resulting in overheating of the motor and ESC. When testing different gearing options, pay close attention to the temperature of the motor and speed control to ensure you are operating within the temperature range of the components. The motor or ESC should never be so hot that it cannot be touched. If temperatures are too hot, a different gearing combination with a lower pinion gear and/or higher spur gear is suggested.

CHANGING THE PINION GEAR/GEAR RATIO

Your vehicle comes with the 24T pinion gear installed for the included 2S battery. If you want to use a 3S battery, install the included 20T pinion gear.

- 1 Unscrew the gear cover screws and remove the gear cover.
- 2 Loosen the motor screws and slide the motor back.
- 3 Loosen the set screw and remove the installed pinion gear.
- 4 Place the new pinion on the end of the motor shaft so the set screw is located over the flat on the shaft.
- 5 Position it so the teeth line up with the spur gear and secure the pinion by tightening the set screw.
- 6 Reinstall the gear cover.

SETTING THE GEAR MESH

The gear mesh has already been set at the factory. Setting the gear mesh is only necessary when changing motors or gears.

Proper gear mesh (how gear teeth meet) is important to the performance of the vehicle. When the gear mesh is too loose, the spur gear could be damaged by the pinion gear of the motor. If the mesh is too tight, speed could be limited and the motor and ESC will overheat.

- 1 Unscrew the gear cover screws and remove the gear cover.
- 2 Loosen the motor screws.
- 3 Put a small piece of paper between the pinion and spur gears.
- 4 Push the gears together while tightening the motor screws.
- 5 Remove the paper. The gears should move a small amount.
- 6 Reinstall the gear cover.



TROUBLESHOOTING GUIDE

PROBLEM	POSSIBLE CAUSE	SOLUTION
Vehicle does not operate	<ul style="list-style-type: none"> » Battery not charged or connected » ESC switch not ON » Transmitter not ON or low battery 	<ul style="list-style-type: none"> » Charge battery/connect » Turn ON ESC switch » Turn ON/replace batteries
Motor runs but rear wheels don't move	<ul style="list-style-type: none"> » Pinion not meshing with spur gear » Pinion spinning on motor shaft » Slipper too loose » Transmission gears stripped » Drive pin broken 	<ul style="list-style-type: none"> » Adjust pinion/spur mesh » Replace pinion gear on motor » Check and adjust slipper » Replace transmission gears » Check and replace drive pin
Steering does not work	<ul style="list-style-type: none"> » Servo plug not in receiver properly » Servo gears or motor damaged 	<ul style="list-style-type: none"> » Check if connected/all the way » Replace or repair servo
Won't turn in one direction	<ul style="list-style-type: none"> » Servo gears damaged 	<ul style="list-style-type: none"> » Replace servo
Motor does not run	<ul style="list-style-type: none"> » Motor plugs loose » Motor wire broken » ESC damaged 	<ul style="list-style-type: none"> » Plug in completely » Repair or replace as needed » Contact Horizon Hobby Product Support
ESC gets hot	<ul style="list-style-type: none"> » Motor over-gearred » Driveline bound up 	<ul style="list-style-type: none"> » Use smaller pinion or larger spur gear on motor » Check wheels, suspension and transmission for binding
Poor run time and/or sluggish acceleration	<ul style="list-style-type: none"> » Ni-MH pack not fully charged » Charger not allowing full charge » Slipper slipping too much » Motor worn out » Driveline bound up 	<ul style="list-style-type: none"> » Recharge battery » Try another charger » Check/adjust slipper » Replace motor » Check wheels, transmission for binding
Poor range and/or glitching	<ul style="list-style-type: none"> » Transmitter batteries low » Vehicle battery low » Loose plugs or wires 	<ul style="list-style-type: none"> » Check and replace » Recharge or replace » Check all wire connections and plugs
Slipper won't adjust	<ul style="list-style-type: none"> » Drive pin missing in shaft » Spur gear face worn out 	<ul style="list-style-type: none"> » Replace drive pin » Replace spur gear and adjust slipper

LIMITED WARRANTY

WHAT THIS WARRANTY COVERS

Horizon Hobby, Inc. (“Horizon”) warrants to the original purchaser that the product purchased (the “Product”) will be free from defects in materials and workmanship at the date of purchase.

WHAT IS NOT COVERED

This warranty is not transferable and does not cover (i) cosmetic damage, (ii) damage due to acts of God, accident, misuse, abuse, negligence, commercial use, or due to improper use, installation, operation or maintenance, (iii) modification of or to any part of the Product, (iv) attempted service by anyone other than a Horizon Hobby authorized service center, (v) Product not purchased from an authorized Horizon dealer, or (vi) Product not compliant with applicable technical regulations.

OTHER THAN THE EXPRESS WARRANTY ABOVE, HORIZON MAKES NO OTHER WARRANTY OR REPRESENTATION, AND HEREBY DISCLAIMS ANY AND ALL IMPLIED WARRANTIES, INCLUDING, WITHOUT LIMITATION, THE IMPLIED WARRANTIES OF NON-INFRINGEMENT, MERCHANTABILITY AND FITNESS FOR A PARTICULAR PURPOSE. THE PURCHASER ACKNOWLEDGES THAT THEY ALONE HAVE DETERMINED THAT THE PRODUCT WILL SUITABLY MEET THE REQUIREMENTS OF THE PURCHASER'S INTENDED USE.

PURCHASER'S REMEDY

Horizon's sole obligation and purchaser's sole and exclusive remedy shall be that Horizon will, at its option, either (i) service, or (ii) replace, any Product determined by Horizon to be defective. Horizon reserves the right to inspect any and all Product(s) involved in a warranty claim. Service or replacement decisions are at the sole discretion of Horizon. Proof of purchase is required for all warranty claims. SERVICE OR REPLACEMENT AS PROVIDED UNDER THIS WARRANTY IS THE PURCHASER'S SOLE AND EXCLUSIVE REMEDY.

LIMITATION OF LIABILITY

HORIZON SHALL NOT BE LIABLE FOR SPECIAL, INDIRECT, INCIDENTAL OR CONSEQUENTIAL DAMAGES, LOSS OF PROFITS OR PRODUCTION OR COMMERCIAL LOSS IN ANY WAY, REGARDLESS OF WHETHER SUCH CLAIM IS BASED IN CONTRACT, WARRANTY, TORT, NEGLIGENCE, STRICT LIABILITY OR ANY OTHER THEORY OF LIABILITY, EVEN IF HORIZON HAS BEEN ADVISED OF THE POSSIBILITY OF SUCH DAMAGES. Further, in no event shall the liability of Horizon exceed the individual price of the Product on which liability is asserted. As Horizon has no control over use, setup, final assembly, modification or misuse, no liability shall be assumed nor accepted for any resulting damage or injury. By the act of use, setup or assembly, the user accepts all resulting liability. If you as the purchaser or user are not prepared to accept the liability associated with the use of the Product, purchaser is advised to return the Product immediately in new and unused condition to the place of purchase.

LAW

These terms are governed by Illinois law (without regard to conflict of law principals). This warranty gives you specific legal rights, and you may also have other rights which vary from state to state. Horizon reserves the right to change or modify this warranty at any time without notice.

WARRANTY SERVICES

QUESTIONS, ASSISTANCE, AND REPAIRS

Your local hobby store and/or place of purchase cannot provide warranty support or service. Once assembly, setup or use of the Product has been started, you must contact your local distributor or Horizon directly. This will enable Horizon to better answer your questions and service you in the event that you may need any assistance. For questions or assistance, please visit our website at www.horizonhobby.com, submit a Product Support Inquiry, or call 877.504.0233 toll free to speak to a Product Support representative.

INSPECTION OR SERVICES

If this Product needs to be inspected or serviced and is compliant in the country you live and use the Product in, please use the Horizon Online Service Request submission process found on our website or call Horizon to obtain a Return Merchandise Authorization (RMA) number. Pack the Product securely using a shipping carton. Please note that original boxes may be included, but are not designed to withstand the rigors of shipping without additional protection. Ship via a carrier that provides tracking and insurance for lost or damaged parcels, as Horizon is not responsible for merchandise until it arrives and is accepted at our facility. An Online Service Request is available at http://www.horizonhobby.com/content/_service-center_render-service-center. If you do not have internet access, please contact Horizon Product Support to obtain a RMA number along with instructions for submitting your product for service. When calling Horizon, you will be asked to provide your complete name, street address, email address and phone number where you can be reached during business hours. When sending product into Horizon, please include your RMA number, a list of the included items, and a brief summary of the problem. A copy of your original sales receipt must be included for warranty consideration. Be sure your name, address, and RMA number are clearly written on the outside of the shipping carton.

NOTICE: Do not ship Li-Po batteries to Horizon. If you have any issue with a Li-Po battery, please contact the appropriate Horizon Product Support office.

WARRANTY REQUIREMENTS

For Warranty consideration, you must include your original sales receipt verifying the proof-of-purchase date. Provided warranty conditions have been met, your Product will be serviced or replaced free of charge. Service or replacement decisions are at the sole discretion of Horizon.

NON-WARRANTY REPAIRS

Should your service not be covered by warranty, service will be completed and payment will be required without notification or estimate of the expense unless the expense exceeds 50% of the retail purchase cost. By submitting the item for service you are agreeing to payment of the service without notification. Service estimates are available upon request. You must include this request with your item submitted for service. Non-warranty service estimates will be billed a minimum of 1/2 hour of labor. In addition you will be billed for return freight. Horizon accepts money orders and cashier's checks, as well as Visa, MasterCard, American Express, and Discover cards. By submitting any item to Horizon for service, you are agreeing to Horizon's Terms and Conditions found on our website http://www.horizonhobby.com/content/_service-center_render-service-center.

NOTICE: Horizon service is limited to Product compliant in the country of use and ownership. If non-compliant product is received by Horizon for service, it will be returned unserviced at the sole expense of the purchaser.

CONTACT INFORMATION

COUNTRY OF PURCHASE	HORIZON HOBBY	ADDRESS	PHONE NUMBER / EMAIL ADDRESS
United States of America	Horizon Service Center (Electronics and engines) Horizon Product Support	4105 Fieldstone Rd Champaign, Illinois 61822 USA	877-504-0233 productsupport@horizonhobby.com
United Kingdom	Horizon Hobby Limited	Units 1-4 Ployters Rd Staple Tye Harlow, Essex CM18 7NS United Kingdom	+44 (0) 1279 641 097 sales@horizonhobby.co.uk
Germany	Horizon Technischer Service	Christian-Junge-Straße 1 25337 Elmshorn, Germany	+49 (0) 4121 2655 100 service@horizonhobby.de
France	Horizon Hobby SAS	11 Rue Georges Charpak 77127 Lieusaint, France	+33 (0) 1 60 18 34 90
China	Horizon Hobby - China	Room 506 No. 97 Changshou Rd. Shanghai, China 200060	+86 (021) 5180 9868 info@horizonhobby.com.cn

FCC STATEMENT //////////////////////////////////////

This device complies with part 15 of the FCC rules. Operation is subject to the following two conditions: (1) This device may not cause harmful interference, and (2) this device must accept any interference received, including interference that may cause undesired operation.

CAUTION: Changes or modifications not expressly approved by the party responsible for compliance could void the user's authority to operate the equipment.

This product contains a radio transmitter with wireless technology which has been tested and found to be compliant with the applicable regulations governing a radio transmitter in the 2.400GHz to 2.4835GHz frequency range.

ANTENNA SEPARATION DISTANCE

When operating your Spektrum transmitter, please be sure to maintain a separation distance of at least 5 cm between your body (excluding fingers, hands, wrists, ankles and feet) and the antenna to meet RF exposure safety requirements as determined by FCC regulations.

The following illustrations show the approximate 5 cm RF exposure area and typical hand placement when operating your Spektrum transmitter.

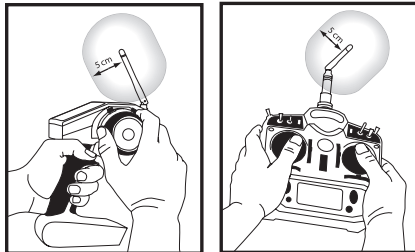

COMPLIANCE INFORMATION FOR THE EUROPEAN UNION //////////////////////////////////////

AT	BE	BG	CZ	CY	DE	DK
ES	FI	FR	GR	HU	IE	IT
LT	LU	LV	MT	NL	PL	PT
RO	SE	SI	SK	UK		

CE DECLARATION OF CONFORMITY (IN ACCORDANCE WITH ISO/IEC 17050-1)

No. HH2012100401

Product(s): VTR Glamis Uno - Single Seat Buggy

Item Number(s): VTR040001

Equipment class: 2

The object of declaration described above is in conformity with the requirements of the specifications listed below, following the provisions of the European R&TTE directive 1999/5/EC; EMC Directive 2004/108/EC and LVD Directive 2006/95/EC:

EN 300-328 V1.7.1: 2006

EN 301 489-1 V1.7.1: 2006

EN 301 489-17 V1.3.2: 2008

EN 60950-1:2006+A12: 2011

EN55022: 2010

EN55024: 2010

EN61000-3-2:2006+A1:2009+A2:2009

EN61000-3-3:2008

Signed for and on behalf of:
Horizon Hobby, Inc.
Champaign, IL USA
Oct 04, 2012

Steven A. Hall
Executive Vice President and Chief Operating Officer
Horizon Hobby, Inc



INSTRUCTIONS FOR DISPOSAL OF WEEE BY USERS IN THE EUROPEAN UNION

This product must not be disposed of with other waste. Instead, it is the user's responsibility to dispose of their waste equipment by handing it over to a designated collection point for the recycling of waste electrical and electronic equipment. The separate collection and recycling of your waste equipment at the time of disposal will help to conserve natural resources and ensure that it is recycled in a manner that protects human health and the environment. For more information about where you can drop off your waste equipment for recycling, please contact your local city office, your household waste disposal service or where you purchased the product.

REPLACEMENT PARTS // ERSATZTEILE // PIÈCES DE RECHANGE // PEZZI DI RICAMBIO //

Part # Nummer Numéro Codice	Description	Beschreibung	Description	Descrizione
DYN4850T	Dynamite Fuze 70A Waterproof Sensorless Brushless ESC	DYN4850T Dynamite Fuze 70A spritzwasserdichter Sensorloser Brushless Regler	Contrôleur brushless sensorless Dynamite Fuze 70A	DYN4850T Dynamite Fuze 70A ESC impermeabile Sensorless Brushless
DYN4833T	Dynamite Fuze 540 4-Pole 3300Kv Sensorless Brushless Motor	DYN4833T Dynamite Fuze 540 4-Pole 3300Kv Sensorloser Brushless Motor	Moteur brushless sensorless Dynamite Fuze 540 4-pôles 3300kV	DYN4833T Dynamite Fuze 540 4-Poli 3300Kv Motore Sensorless Brushless
SPMR2400	DX2L DSM 2-Channel Surface Radio	SPMR2400 DX2L DSM 2-Kanal Surface Fernsteuerung	Radio 2 voies DX2L DSM, surface	SPMR2400 DX2L DSM radio 2 canali
SPMSR200WP	SR200WP 2-Channel DSM Waterproof Sport Receiver	SPMSR200WP SR200WP 2-Kanal DSM spritzwassergeschützter Sport Empfänger	Récepteur 2 voies étanche SR200WP DSM	SPMSR200WP SR200WP ricevitore impermeabile 2-canali DSM
DYN5204EC	Dynamite Speedpack Silver 2S 7.4V 3000mAh 20C Li-Po Battery	DYN5204EC Dynamite Speek Pack Silver 2S 7.4V 3000mAh 20C Li-Po Akku	Batterie Li-Po Dynamite Speed pack Silver 7.4V 2S 3000mA 20C	DYN5204EC Dynamite Speek Pack Silver batteria LiPo 2S 7.4V 3000mAh 20C
DYN4114	10W Li-Po AC Balance Charger	DYN4114 10W Li-Po AC Balance Ladegerät	Chargeur AC équilibreur li-Po 10W	DYN4114 10W Li-Po AC Caricatore con bilanciamento

BATTERY BOX // AKKUBOX // COMPARTIMENT À BATTERIE // SCATOLA BATTERIA: GL //////////////////////////////////////

Part # Nummer Numéro Codice	Description	Beschreibung	Description	Descrizione
VTR235107	M3 x 10mm Button Head Screw (10)	M3 x 10mm Halbrundschauben (10)	Vis à tête bombée M3 x 10mm (10)	Viti testa tonda M3 x 10mm (10)
DYN4850	Fuze 70A Brushless Waterproof ESC	Fuze 70A spritzwasserdichter Brushless Regler	Contrôleur brushless Fuze 70A	Fuze 70A ESC impermeabile Brushless
VTR241011	ESC Mount: GL	Montageplatte Fahrtenregler: GL	Support de contrôleur: GL	Supporto ESC: GL
VTR235176	M3 x 10mm Flat Head Screw (10)	M3 x 10mm Flachkopfschrauben (10)	Vis à tête fraisée M3 x 10mm (10)	Viti a testa piatta M3 x 10mm (10)
VTR246000	Body Clips, Mini (10)	Karosseriekammern Mini (10):GL	Mini clips à carrosserie (10): GL	Clips mini per carrozzeria (10)
VTR240000	Body Mount Set, Front & Sides: GL	Gehäusebefestigungen, Front and Sides: GL	Supports de carrosserie, frontaux et latéraux: GL	Staffe Chassis, anteriori e laterali: GL
VTR241009	Battery Box: GL	Akkubox: GL	Compartiment à batterie: GL	Scatola batteria: GL
VTR235109	M3 x 14mm Button Head Screw (10)	M3 x 14mm Halbrundschauben (10)	Vis à tête bombée M3 x 14mm (10)	Viti testa tonda M3 x 14mm (10)

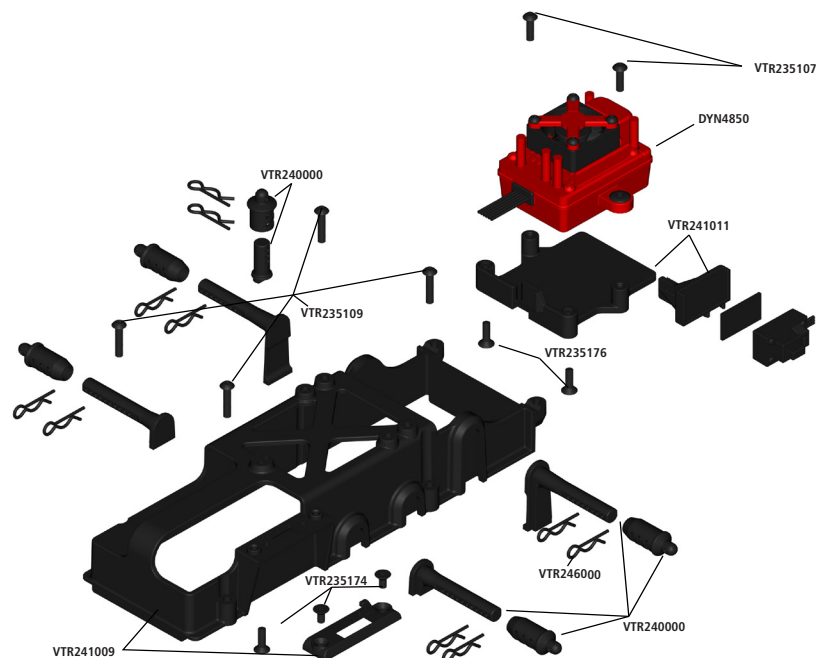

// **BATTERY COVER // BATTERIEFACHABDECKUNG // CACHE DES PILES // COPERCHIO DELLE PILE //**

Part # Nummer Numéro Codice	Description	Beschreibung	Description	Descrizione
VTR235174	M3 x 6mm Flat Head Screw (10)	M3 x 6mm Flachkopfschrauben (10)	Vis à tête fraisée M3 x 6mm (10)	Viti a testa piatta M3 x 6mm (10)
VTR241008	Battery Hatch Cover: GL	Akkudeckel:GL	Couvercle de batterie: GL	Coperchio batteria: GL



DIFFERENTIAL GEAR ASSEMBLY // DIFFERENZIAL ////////////////////////////////////// DIFFERENTIAL ASSEMBLAGE DU DIFFÉRENTIEL À PIGNONS // GRUPPO INGRANAGGI DIFFERENZIALE

Part # Numer Numéro Codice	Description	Beschreibung	Description	Descrizione
VTR242000	Diff Case Halves: GL	Diffgehäuse Halb: GL	Demies coquilles de différentiel: GL	Scatola differenziale: GL
VTR242006	Differential Internals: GL	Diffgehäuse Halb: GL	Demies coquilles de différentiel: GL	Scatola differenziale: GL
VTR242008	Ring Gear, 64T, 48P	Tellerrad 64T 48P	Couronne 64T, 48P: GL	Anello dentato, 64T, 48P
VTR237029	12mm x 18mm x 4mm Ball Bearing (2)	12mm x 18mm x 4mm Kugel-lager (2)	Roulement 12mm x 18mm x 4mm (2)	Cuscinetto a sfere 12mm x 18mm x 4mm (2)
VTR242009	Outdrives, Diff (2)	Antriebsklauen / Diff (2)	Noix de sortie de différentiel (2): GL	Uscite differenz (2)
VTR235222	M2,8 x 10mm Cap Head Screw Self Tapping (10)	M2,8 x 10mm Innensechskantschrauben selbstschneidene (10)	Vis à tête creuse auto-taraudeuses M2,8 x 10mm (10)	Viti a testa bombata autofilettanti M2,8 x 10mm (10)
VTR235223	M2,8 x 14mm Cap Head Screw Self Tapping (10)	M2,8 x 14mm Innensechskantschrauben selbstschneidene (10)	Vis à tête creuse auto-taraudeuses M2,8 x 14mm (10)	Viti a testa bombata autofilettanti M2,8 x 14mm (10)
VTR235030	M3 x 18mm Cap Head Screw (10)	M3 x 18mm Innensechskantschrauben (10)	Vis à tête creuse M3 x 18mm (10)	Viti a testa bombata M3 x 18mm (10)
VTR236014	M3 Nylock Nut (10)	M3 Muttern Nylock (10)	Ecrou auto-freiné M3 (10)	Dado Nylock M3 (10)

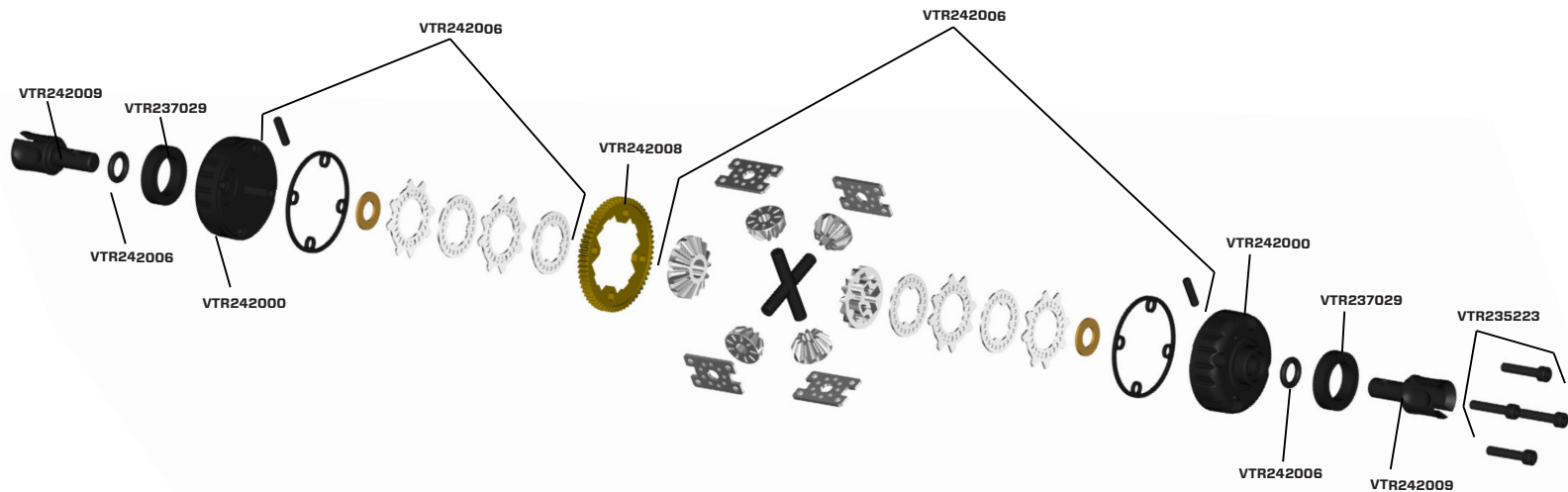

FRONT SHOCK ASSEMBLY // STOSSDÄMPFER VORNE ////////////////////////////////////// ASSEMBLAGE DES AMORTISSEURS AVANT // GRUPPO AMMORTIZZ. ANTERIORE

Part # Nummer Numéro Codice	Description	Beschreibung	Description	Descrizione
VTR243006	Shock Cap (2): GL	Dämpferkappen (2): GL	Bouchon d'amortisseur (2): GL	Tappo ammortizz. (2): GL
VTR246005	Flanged Pivot Ball, 5.8mm x 3mm x 7mm (10)	Kugelkopf mit Flansch 5.8mm x 3mm x 7mm (10): GL	Rotules épaulées 5,8x3x7mm (10): GL	Perno sfera flangiata 5,8x3mmx7mm (10)
VTR243002	Shock Plastics: GL	Dämpfer Kunststoff: GL	Pièces plastiques d'amortisseurs: GL	Parti in plastica ammortizzatori: GL
VTR235095	M2.5 x 4mm Button Head Screw (10)	M2,5 x 4mm Halbrundsrauben (10)	Vis à tête bombée M2,5 x 4mm (10)	Viti testa tonda M2,5 x 4mm (10)
VTR243010	O-Ring, Bleeder Screw (4)	O-Ring / Entlüftungsschraube (4)	Joint torique de vis de purge d'amortisseurs (4): GL	O-ring, vite spurgo (4)
VTR243009	O-Ring, Top Cap (4)	O-Ring / Dämpferkappe (4)	Joints toriques de bouchons d'amortisseurs (4): GL	O-ring, tappo super. (4)
VTR236013	M2.5 Nylock Nut (10)	M2,5 Muttern Nylock (10)	Ecrou auto-freiné M2,5 (10)	Dado Nylock M2,5 (10)
VTR243003	Shock Pistons: GL	Kolbenplatten: GL	Pistons d'amortisseurs: GL	Pistoni ammortizzatori: GL
VTR236104	2.5mm x 4.6mm x .5mm Washer (10)	2,5mm x 4,6mm x ,5mm Unterlegscheiben	Rondelle 2,5mm x 4,6mm x ,5mm	Rondella 2,5mm x 4,6mm x ,5mm
VTR243011	Shock Shaft, 3mm x 53mm (2)	Kolbenstange, 3mm x 53mm (2)	Tige d'amortisseurs 3x53mm (2): GL	Albero ammortizz. 3x53mm (2)
VTR243000	Front Shock Body, Plastic: GL	Stoßdämpfergehäuse Kunststoff vorne: GL	Corps d'amortisseur avant en plastique: GL	Corpo ammortizzatore anteriore plastica: GL
VTR243004	Shock Bottom Cap, Plastic: GL	Dämpferkappen Oben / Kunststoff: GL	Bouchon inférieur d'amortisseur: GL	Tappo infer. ammortizzatore in plastica: GL
VTR243008	O-Ring, Shocks (8)	O-Ring / Dämpfer (8)	Joints toriques d'amortisseurs (8): GL	O-ring, ammortizz. (8)
VTR243013	Spring, Front, 2.9: GL	O-Ring / Dämpfer (8)	Joints toriques d'amortisseurs (8): GL	O-ring, ammortizz. (8)
VTR243007	Shock Boots: GL	Staubschutzmanchetten Dämpfer: GL	Chaussettes d'amortisseurs (2): GL	Protezione ammortizz. : GL

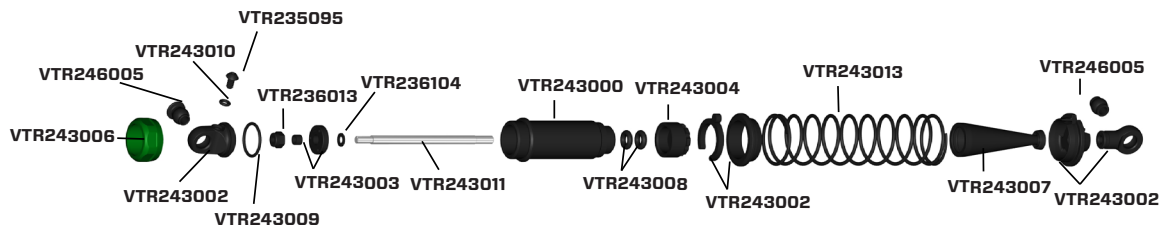

FRONT TIRE ASSEMBLY // REIFEN VORNE // MONTAGE DES PNEUS AVANT // GRUPPO GOMME ANTERIORI //

Part # Nummer Numéro Codice	Description	Beschreibung	Description	Descrizione
VTR235222	M2,8 x 10mm Cap Head Screw Self Tapping (10)	M2,8 x 10mm Innensechskantschrauben selbstschneidene (10)	Vis à tête creuse auto-taraudeuses M2,8 x 10mm (10)	Viti a testa bombata autofilettanti M2,8 x 10mm (10)
VTR44000	Black Front Wheels(2): GL	Vorderer Radkranz, Schwarz: GL	Jantes AV, Noires, (2): GL	Ruota anteriore, nero: GL
VTR44002	Front Tire, Ribbed w/Foam, Med, 40mm(2): GL	Vorderrreifen Ribbed Medium inkl. Einlage 40mm (2): GL	Pneus avant lignés avec insert, moyen, 40mm (2): GL	Gomma anteriore rigata, con spugna, med, 40mm (2): GL

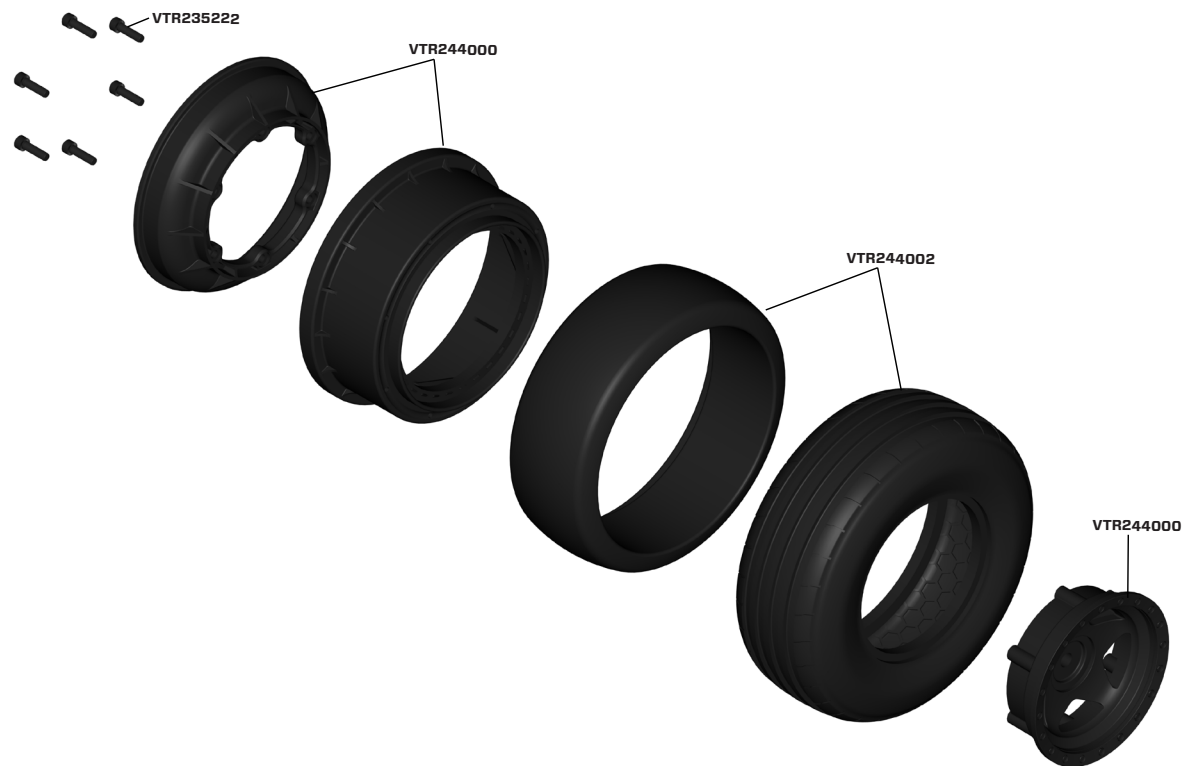

GEAR ASSEMBLY // GETRIEBE // MONTAGE DU SLIPPER // GRUPPO INGRANAGGI //////////////////////////////////////

Part # Nummer Numéro Codice	Description	Beschreibung	Description	Descrizione
VTR237009	5mm x 13mm x 4mm Ball Bearing (2)	5mm x 13mm x 4mm Kugellager (2)	Roulement 5mm x 13mm x 4mm (2)	Cuscinetto a sfere 5mm x 13mm x 4mm (2)
VTR242003	Spur Gear, 87T: GL	Hauptzahnrad, 87T: GL	Couronne 87T: GL	Corona 87T: GL
VTR242013	Slipper Pad (2): GL	Slipper Pad (2): GL	Garnitures de slipper (2): GL	Slipper pad (2): GL
VTR242012	Slipper Disk (2): GL	Slipper Disk (2): GL	Plateaux de slipper (2): GL	Disco slipper (2): GL
VTR242014	Slipper Spring, Hub: GL	Slipper Feder / Zentrierstück: GL	Moyeu et ressort de slipper: GL	Molla slipper, mozzo: GL
VTR242001	Transmission Case Plastics: GL	Getriebegehäuse: GL	Ensemble carter de transmission: GL	Set scatola trasmissione: GL



FRONT STEERING // LENKUNG // ASSEMBLAGE DE LA DIRECTION // STERZO ANTERIORE //////////////////////////////////////

Part # Nummer Numéro Codice	Description	Beschreibung	Description	Descrizione
VTR235106	M3 x 8mm Button Head Screw (10)	M3 x 8mm Halbrundschauben (10)	Vis à tête bombée M3 x 8mm (10)	Viti testa tonda M3 x 8mm (10)
VTR236076	3.2mm x 7mm x .5mm Washer (10)	3,2mm x 7mm x ,5mm Unterlegscheiben (10)	Rondelle 3,2mm x 7mm x ,5mm (10)	Rondella 3,2mm x 7mm x ,5mm (10)
VTR241004	Mounts, Servo/Bellcrank: GL	Befestigung Servo/Umlenkung: GL	Supports de servos et renvois: GL	Supporti servi/squadrette: GL
VTR235107	M3 x 10mm Button Head Screw (10)	M3 x 10mm Halbrundschauben (10)	Vis à tête bombée M3 x 10mm (10)	Viti testa tonda M3 x 10mm (10)
VTR241005	Steering Rod Ends, 4.8mm: GL	Kugelpfannen für Lenkung 4.8mm: GL	Chapes de direction 4,8mm: GL	Snodi sterzo, 4,8mm: GL
VTR246002	Ball Stud, 4.8mm x 12mm (10)	Kugelpfannen für Lenkung 4.8mm: GL	Chapes de direction 4,8mm: GL	Snodi sterzo, 4,8mm: GL
VTR241003	Steering Bellcranks, Horns: GL	Anlenkenseit für Lenkung: GL	Renvois de direction: GL	Squadrette sterzo: GL
VTR235222	M2,8 x 10mm Cap Head Screw Self Tapping (10)	M2,8 x 10mm Innensechskantschrauben selbstschneidene (10)	Vis à tête creuse auto-taraudeuses M2,8 x 10mm (10)	Viti a testa bombata autofilettanti M2,8 x 10mm (10)
VTR241015	Servo Saver Post, Spring: GL	Servosaver Stehbolzen / Feder: GL	Support de sauve servo avec ressort: GL	Salvaservo poster., molla: GL
VTR236014	M3 Nylock Nut (10)	M3 Muttern Nylock (10)	Ecrou auto-freiné M3 (10)	Dado Nylock M3 (10)
VTR246003	Flange Pipe, Steering Bar (2): GL	Flansch Ackermann: GL	Barre de direction, tube à brides (2): GL	Flagia tubo, barra sterzo (2): GL
VTR246010	Hinge Pin, 3mm x 34mm (2)	Getriebegehäuse: GL	Ensemble carter de transmission: GL	Set scatola trasmissione: GL
VTR235109	M3 x 14mm Button Head Screw (10)	M3 x 14mm Halbrundschauben (10)	Vis à tête bombée M3 x 14mm (10)	Viti testa tonda M3 x 14mm (10)
VTR236078	4.3mm x 9mm x .8mm Washer (10)	4,3mm x 9mm x ,8mm Unterlegscheiben (10)	Rondelle 4,3mm x 9mm x ,8mm (10)	Rondella 4,3mm x 9mm x ,8mm(10)

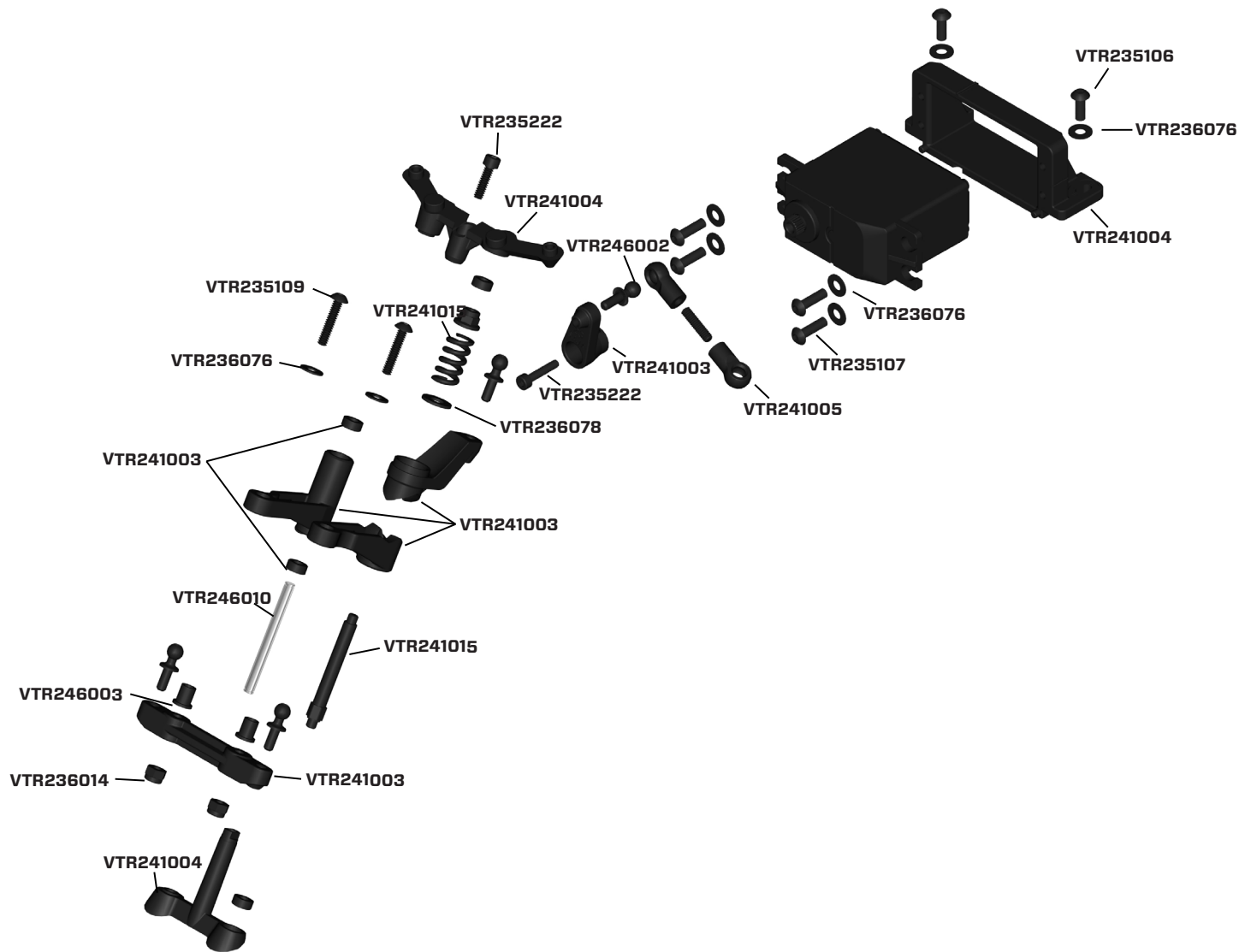

GEAR BOX // GETRIEBEGEHÄUSE // ASSEMBLAGE DE LA BOÎTE DE TRANSMISSION // SCATOLA INGRANAGGI //////////////////////////////////////

Part # Nummer Numéro Codice	Description	Beschreibung	Description	Descrizione
VTR242002	Gear Cover: GL	Getriebeabdeckung GL	Carter de Réducteur: GL	Copertura per ingranaggi: GL
VTR235106	M3 x 8mm Button Head Screw (10)	M3 x 8mm Halbrundschauben (10)	Vis à tête bombée M3 x 8mm (10)	Viti testa tonda M3 x 8mm (10)
VTR242005	Top Shaft Assembly: GL	Stiftschraube (10): GL	Axe supérieur complet: GL	Insieme albero super.: GL
VTR232033	Pinion Gear 24T, 48P/M3x3 Set Screw	Ritzel 24T, 48P/M3x3 Gewindestift	Pignon conique 24T, 48P/Vis Imbus M3x3	Ruota conica passo 24T, 48P/Grani M3x3
VTR232029	Pinion Gear 20T, 48P/M3x3 Set Screw	Ritzel 20T, 48P/M3x3 Gewindestift	Pignon conique 20T, 48P/Vis Imbus M3x3	Ruota conica passo 20T, 48P/Grani M3x3
VTR235025	M3 x 8mm Cap Head Screw (10)	M3 x 8mm Innensechskantschrauben (10)	Vis à tête creuse M3 x 8mm (10)	Viti a testa bombata M3 x 8mm (10)
VTR236076	3,2mm x 7mm x ,5mm Washer (10)	3,2mm x 7mm x ,5mm Unterlegscheiben (10)	Rondelle 3,2mm x 7mm x ,5mm (10)	Rondella 3,2mm x 7mm x ,5mm (10)
VTR242010	Motor Plate: GL	Motormontageplatte: GL	Platine moteur: GL	Piastra motore: GL
VTR237004	5mm x 10mm x 4mm Ball Bearing (2)	5mm x 10mm x 4mm Kugellager (2)	Roulement 5mm x 10mm x 4mm (2)	Cuscinetto a sfere 5mm x 10mm x 4mm (2)
VTR242001	Transmission Case Plastics: GL	Getriebegehäuse: GL	Ensemble carter de transmission: GL	Set scatola trasmissione: GL
VTR242011	Middle Gear, 29T, 48P w/Snap Rings	Mittelgetriebe 29T / 48p inkl. Federring	Pignon intermédiaire 29T, 48P avec anneaux GL	Ingran. centrale, 29T, 48P c/seegeer
VTR237014	6mm x 12mm x 4mm Ball Bearing (2)	6mm x 12mm x 4mm Kugellager (2)	Roulement 6mm x 12mm x 4mm (2)	Cuscinetto a sfere 6mm x 12mm x 4mm (2)
VTR235034	M3 x 28mm Cap Head Screw (10)	M3 x 28mm Innensechskantschrauben (10)	Vis à tête creuse M3 x 28mm (10)	Viti a testa bombata M3 x 28mm (10)
VTR235222	M2,8 x 10mm Cap Head Screw Self Tapping (10)	M2,8 x 10mm Innensechskantschrauben selbstschneidene (10)	Vis à tête creuse auto-taraudeuses M2,8 x 10mm (10)	Viti a testa bombata autofilettanti M2,8 x 10mm (10)
DYN4833	Dynamite Fuze 540 4-Pole 3300Kv Sensorless Brushless Motor	DYN4833T Dynamite Fuze 540 4-Pole 3300Kv Sensorloser Brushless Motor	Moteur brushless sensorless Dynamite Fuze 540 4-pôles 3300kv	DYN4833T Dynamite Fuze 540 4-Poli 3300Kv Motore Sensorless Brushless

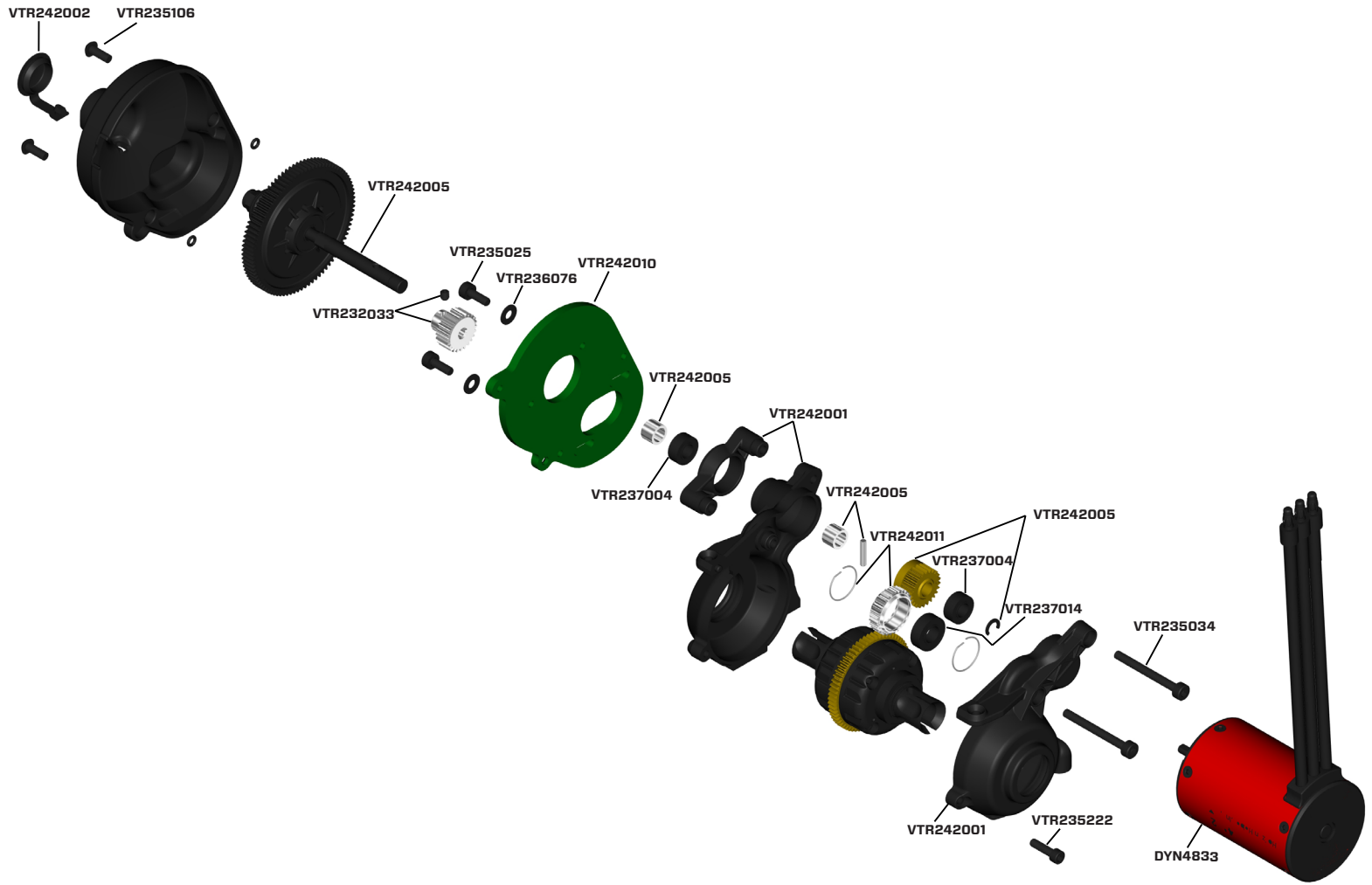

FRONT CLIP // FRONTCLIP // ASSEMBLAGE DU TRAIN AVANT // CLIP ANTERIORE //////////////////////////////////////

Part # Nummer Numéro Codice	Description	Beschreibung	Description	Descrizione
VTR240001	Light Buckets: GL	Stoßdämpfer Endkappe: GL	Cuvelages de phares: GL	Sedi fanali: GL
VTR235107	M3 x 10mm Button Head Screw (10)	M3 x 10mm Halbrundsrauben (10)	Vis à tête bombée M3 x 10mm (10)	Viti testa tonda M3 x 10mm (10)
VTR240000	Body Mount Set, Front & Sides: GL	Gehäusebefestigungen, Front and Sides: GL	Supports de carrosserie, frontaux et latéraux: GL	Staffe Chassis, anteriori e laterali: GL
VTR246004	Body Clip, 6mm (10)	Karosseriekammern 6mm (10):GL	6mm clips à carrosserie (10): GL	Clips 6mm per carrozzeria (10)
VTR241001	Front Bumper: GL	Frontstoßstange: GL	Pare-choc AV: GL	Paraurti anteriore: GL
VTR241014	Fr, Rr Mount Plates: GL	Stoßfänger Vorne: GL	Platines de fixation av/arr: GL	Piastre montaggio ant. post.: GL
VTR241013	Chassis, Aluminum: GL	Chassie Aluminium: GL	Châssis en aluminium: GL	Telaio alluminio: GL
VTR241000	Front Tower, Supports, Covers: GL	Vorderer Dämpferdom: GL	Support d'amortisseurs avant avec protections: GL	Torre ammortizzatore anteriore: GL
VTR235174	M3 x 6mm Flat Head Screw (10)	M3 x 6mm Flachkopfschrauben (10)	Vis à tête fraisée M3 x 6mm (10)	Viti a testa piatta M3 x 6mm (10)
VTR235176	M3 x 10mm Flat Head Screw (10)	M3 x 10mm Flachkopfschrauben (10)	Vis à tête fraisée M3 x 10mm (10)	Viti a testa piatta M3 x 10mm (10)
VTR246009	Turnbuckle, 4-40 x 50mm (2)	Lenkstange 4-40 x 50mm (2)	Biellettes 4-40x50mm (2): GL	Tenditore, 4-40x50mm (2)
VTR241002	Rod Ends: GL	Gelenkkopf: GL	Chapes: GL	Estremità barra: GL
VTR246002	Ball Stud, 4.8mm x 12mm (10)	Lenkstange 4.8mm x 12mm (10)	Biellettes 4.8mm x 12mm (10)	Tenditore, 4,8mm x 12mm (10)
VTR246001	Screw Pin, Clip Post (10)	Stiftschraube (10) :GL	Supports de clips avec goupilles (10): GL	Perni viti clip (10)
VTR236044	M5 Nylock Flanged Serrated Nut (10)	M3 Muttern Nylock angeflanscht gezackt (10)	Ecrou auto-freiné épaulé rainuré M3 (10)	Dado Nylock flangiato seghettato M3 (10)
VTR244001	Front Hub, Carrier, Hex: GL	Naben, Rad Träger, Sechskant: GL	Fusée avant, Etrier porte-fusée, hexagone: GL	Mozzi, Supporto, Dado: GL
VTR237004	5mm x 10mm x 4mm Ball Bearing (2)	5mm x 10mm x 4mm Kugellager (2)	Roulement 5mm x 10mm x 4mm (2)	Cuscinetto a sfere 5mm x 10mm x 4mm (2)
VTR242007	Stub Axle, Front (2): GL	Radachse mit Flansch Hinten (2): GL	Axe de roue arrière en acier (2): GL	Perno ruota poster. (2): GL
VTR246006	Hinge Pin, 3mm x 29mm (2)	Hinge Pin, 3mm x 29mm (2)	Axes de suspension 3x29mm (2): GL	Perno cerniera 3x29mm (2)
VTR236131	E-Clip, 3mm (10)	E-Clip 3mm (10)	E-Clip 3mm (10)	E-Clip 3mm (10)
VTR244000	Suspension Arm Set: GL	Querlenker Set: GL	Set de bras de suspension: GL	Set braccetti sospensioni: GL
VTR235113	M3 x 25mm Button Head Screw (10)	M3 x 25mm Halbrundsrauben (10)	Vis à tête bombée M3 x 25mm (10)	Viti testa tonda M3 x 25mm (10)
VTR235178	M3 x 14mm Flat Head Screw (10)	M3 x 14mm Flachkopfschrauben (10)	Vis à tête fraisée M3 x 14mm (10)	Viti a testa piatta M3 x 14mm (10)
VTR246007	Hinge Pin, 3mm x 51mm (2)	Hinge Pin, 3mm x 51mm (2)	Axes de suspension 3x51mm (2): GL	Perno cerniera 3x51mm (2)

REAR CLIP // HECKCLIP // ASSEMBLAGE DU TRAIN ARRIÈRE // CLIP POSTERIORE //////////////////////////////////////

Part # Nummer Numéro Codice	Description	Beschreibung	Description	Descrizione
VTR241007	Rear Shock Tower, Roll Bar, Mounts: GL	Dämpferbrücke Hinten: GL	Support d'amortisseurs arrière avec barre de protection et supports: GL	Supporto ammortizz. poster., roll bar: GL
VTR236024	M3 Nylock Flanged Nut (10)	M3 Muttern Nylock angeflanscht (10)	Ecrou auto-freiné bride M3 (10)	Dado Nylock flangiato M3 (10)
VTR235177	M3 x 12mm Flat Head Screw (10)	M3 x 12mm Flachkopfschrauben (10)	Vis à tête fraisée M3 x 12mm (10)	Viti a testa piatta M3 x 12mm (10)
VTR235222	M2,8 x 10mm Cap Head Screw Self Tapping (10)	M2,8 x 10mm Innensechskantschrauben selbstschneidene (10)	Vis à tête creuse auto-taraudeuses M2,8 x 10mm (10)	Viti a testa bombata autofilettanti M2,8 x 10mm (10)
VTR235030	M3 x 18mm Cap Head Screw (10)	M3 x 18mm Innensechskantschrauben (10)	Vis à tête creuse M3 x 18mm (10)	Viti a testa bombata M3 x 18mm (10)
VTR235113	M3 x 25mm Button Head Screw (10)	M3 x 25mm Halbrundschrauben (10)	Vis à tête bombée M3 x 25mm (10)	Viti testa tonda M3 x 25mm (10)
VTR235109	M3 x 14mm Button Head Screw (10)	M3 x 14mm Halbrundschrauben (10)	Vis à tête bombée M3 x 14mm (10)	Viti testa tonda M3 x 14mm (10)
VTR242004	Rear Motor Guard, Supports: GL	Radträger Hinten (2):GL	Protection arrière de moteur: GL	Protezione motore posteriore, supporti: GL
VTR241006	Rear Camber Mount, Support: GL	Sturzblock hinten: GL	Bloc de carrossage arrière: GL	Blocco camber posteriore: GL
VTR242016	Boot, Outdrive (4): GL	Staubschutzmanchetten / Antriebsklauen (4): GL	Soufflets de cardan (4): GL	Protezione perni (4): GL
VTR242018	Stub Axle, Rear (2): GL	Radachse mit Flansch Vorne (2): GL	Axes de roues avant en acier (2): GL	Perno ruota anter. (2): GL
VTR237009	5mm x 13mm x 4mm Ball Bearing (2)	5mm x 13mm x 4mm Kugellager (2)	Roulement 5mm x 13mm x 4mm (2)	Cuscinetto a sfere 5mm x 13mm x 4mm (2)
VTR246002	Ball Stud, 4.8mm x 12mm (10)	Lenkstange 4.8mm x 12mm (10)	Biellettes 4.8mm x 12mm (10)	Tenditore, 4,8mm x 12mm (10)
VTR244003	Rear Hub(2):GL	Radträger Hinten (2): GL	Fusées arrière (2): GL	Mozzo posteriore (2):GL
VTR246001	Screw Pin, Clip Post (10)	Stiftschraube (10) :GL	Supports de clips avec goupilles (10): GL	Perni viti clip (10)
VTR242019	Hex Adapter, 12mm x 6mm	Radmitnehmer 12mm x 6mm	Hexagone 12x6mm: GL	Adattatore esagonale 12x6mm
VTR236044	M5 Nylock Flanged Serrated Nut (10)	M3 Muttern Nylock angeflanscht gezackt (10)	Ecrou auto-freiné épaulé rainuré M3 (10)	Dado Nylock flangiato seghettato M3 (10)
VTR246009	Turnbuckle, 4-40 x 50mm (2)	Lenkstange 4-40 x 50mm (2)	Biellettes 4-40x50mm (2): GL	Tenditore, 4-40x50mm (2)
VTR241002	Rod Ends: GL	Gelenkkopf: GL	Chapes: GL	Estremità barra: GL
VTR242017	Dogbone, Rear (2): GL	Antriebsknochen Hinten (2): GL	Cardan arrière (2): GL	Alberi trasm. posteriore (2): GL
VTR236131	E-Clip, 3mm (10)	E-Clip 3mm (10)	E-Clip 3mm (10)	E-Clip 3mm (10)
VTR244000	Suspension Arm Set: GL	Querlenker Set: GL	Set de bras de suspension: GL	Set braccetti sospensioni: GL
VTR246010	Hinge Pin, 3mm x 34mm (2)	Hinge Pin, 3mm x 34mm (2)	Axes de suspension 3x34mm (2): GL	Perno cerniera 3x34mm (2)

Part # Nummer Numéro Codice	Description	Beschreibung	Description	Descrizione
VTR235178	M3 x 14mm Flat Head Screw (10)	M3 x 14mm Flachkopfschrauben (10)	Vis à tête fraisée M3 x 14mm (10)	Viti a testa piatta M3 x 14mm (10)
VTR235174	M3 x 6mm Flat Head Screw (10)	M3 x 6mm Flachkopfschrauben (10)	Vis à tête fraisée M3 x 6mm (10)	Viti a testa piatta M3 x 6mm (10)
VTR241014	Fr, Rr Mount Plates: GL	Stoßfänger Vorne: GL	Platines de fixation av/arr: GL	Piastre montaggio ant. post.: GL
VTR246007	Hinge Pin, 3mm x 51mm (2)	Hinge Pin, 3mm x 51mm (2)	Axes de suspension 3x51mm (2): GL	Perno cerniera 3x51mm (2)
VTR241006	Rear Camber Mount, Support: GL	Hinge Pin, 3mm x 51mm (2)	Axes de suspension 3x51mm (2): GL	Perno cerniera 3x51mm (2)
VTR244002	Suspension Pivots, Brace: GL	Stabisatz: GL	Set d'axes et renforts de suspension: GL	Supporti braccetti sosp. : GL

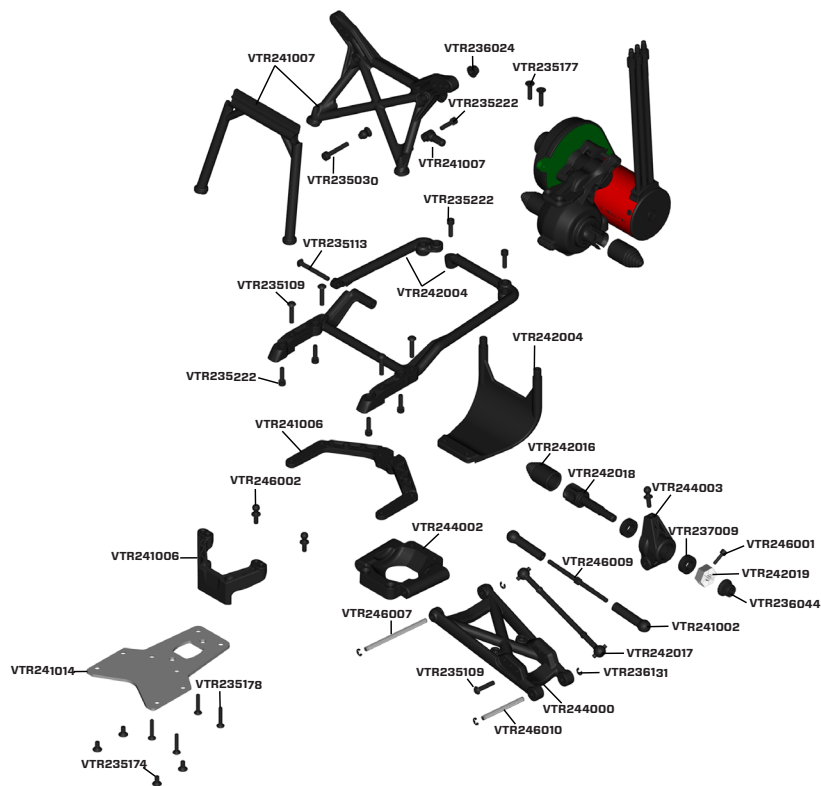

REAR TIRE ASSEMBLY // REIFEN HINTEN // MONTAGE DES PNEUS AVANT // GRUPPO GOMMA POSTERIORE // // // // //

Part # Nummer Numéro Codice	Description	Beschreibung	Description	Descrizione
VTR235222	M2,8 x 10mm Cap Head Screw Self Tapping (10)	M2,8 x 10mm Innensechskantschrauben selbstschneidene (10)	Vis à tête creuse auto-taraudeuses M2,8 x 10mm (10)	Viti a testa bombata autofilettanti M2,8 x 10mm (10)
VTR44001	Black Rear Wheels(2): GL	Hinterrad, Schwarz: GL	Jantes AR, Noires, (2): GL	Ruota posteriore, nero: GL
VTR44003	Rear Tire, Tetrapod w/Foam, Med, 50mm (2): GL	Reifensatz Tetrapod Hinten Medium inkl. Einlage 50mm (2): GL	Pneus arrière Tetrapod avec insert, moyen, 50mm (2): GL	Gomma poster. Tetrapod c/spugna, med, 50mm (2): GL

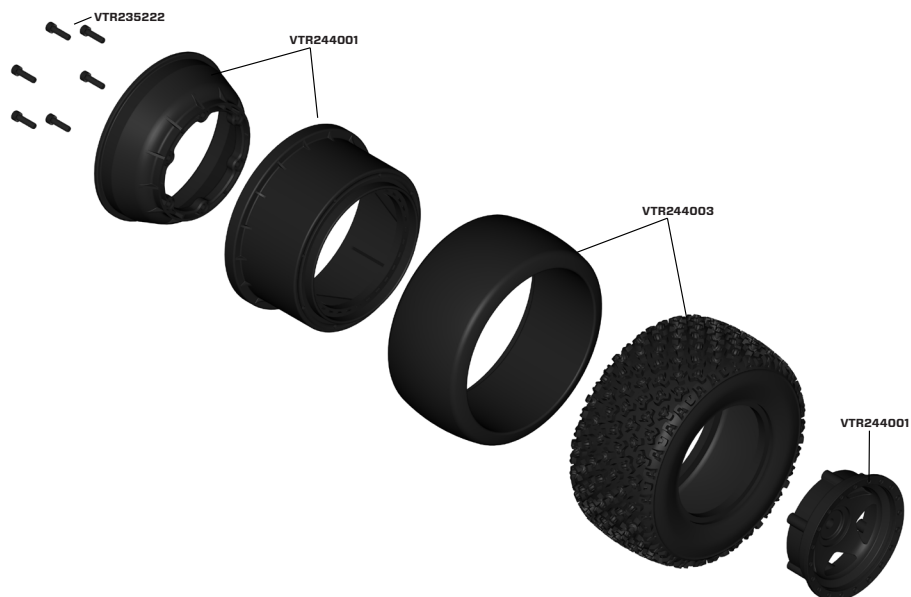

RECEIVER BOX // EMPFÄNGERBOX // ASSEMBLAGE DU COMPARTIMENT RADIO // SCATOLA RICEVITORE //

Part # Nummer Numéro Codice	Description	Beschreibung	Description	Descrizione
VTR241010	Receiver Box: GL	Empfängerbox: GL	Boîtier radio: GL	Scatola ricevitore: GL
VTR241016	Receiver Box Seals: GL	Empfängerboxdichtung	Joints de compartiment radio: GL	Guarnizioni scatola radio: GL
VTR241012	Cap, Antenna (5)	Antennenkappe (5): GL	Capuchon d'antenne (5): GL	Tappo antenna (5)
VTR235222	M2,8 x 10mm Cap Head Screw Self Tapping (10)	M2,8 x 10mm Innensechskantschrauben selbstschneidene (10)	Vis à tête creuse auto-taraudeuses M2,8 x 10mm (10)	Viti a testa bombata autofilettanti M2,8 x 10mm (10)
VTR235322	M3 x 5mm Cup Point Set Screw (10)	M3 x 5mm Ringschneide Gewindestift (10)	Vis Imbus à bout cuvette M3 x 5mm (10)	Tazza punto grani M3 x 5mm (10)
SPMSR200WP	SR200WP 2-Channel DSM Waterproof Sport Receiver	SPMSR200WP SR200WP 2-Kanal DSM spritwassergeschützter Sport Empfänger	Récepteur 2 voies étanche SR200WP DSM	SPMSR200WP SR200WP ricevitore impermeabile 2-canali DSM

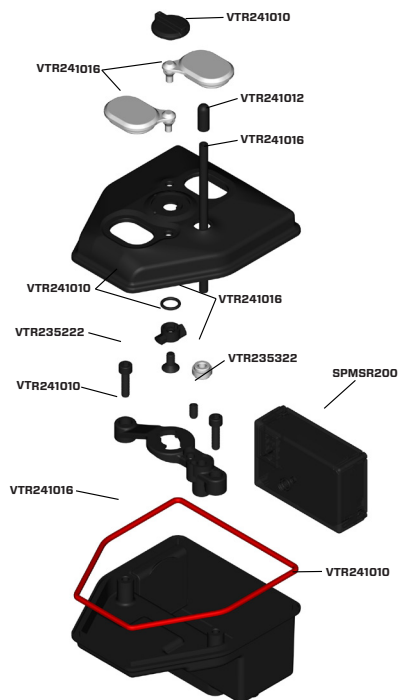

REAR SHOCK ASSEMBLY // STOSSDÄMPFER HINTEN ////////////////////////////////////// ASSEMBLAGE DES AMORTISSEURS ARRIÈRE // GRUPPO AMMORTIZZ. POSTERIORE

Part # Nummer Numéro Codice	Description	Beschreibung	Description	Descrizione
VTR243006	Shock Cap (2): GL	Dämpferkappen (2): GL	Bouchon d'amortisseur (2): GL	Tappo ammortizz. (2): GL
VTR246005	Flanged Pivot Ball, 5,8mm x 3mm x 7mm (10)	Kugelkopf mit Flansch 5,8mm x 3mm x 7mm (10): GL	Rotules épaulées 5,8x3x7mm (10): GL	Perno sfera flangiata 5,8x3mmx7mm (10)
VTR243002	Shock Plastics: GL	Dämpfer Kunststoff: GL	Pièces plastiques d'amortisseurs: GL	Parti in pastica ammortizzatori: GL
VTR235095	M2.5 x 4mm Button Head Screw (10)	M2,5 x 4mm Halbrundschauben (10)	Vis à tête bombée M2.5 x 4mm (10)	Viti testa tonda M2.5 x 4mm (10)
VTR243010	O-Ring, Bleeder Screw (4)	O-Ring / Entlüftungsschraube (4)	Joint torique de vis de purge d'amortisseurs (4): GL	O-ring, vite spurgo (4)
VTR243009	O-Ring, Top Cap (4)	O-Ring / Dämpferkappe (4)	Joints toriques de bouchons d'amortisseurs (4): GL	O-ring, tappo super. (4)
VTR236013	M2.5 Nylock Nut (10)	M2,5 Muttern Nylock (10)	Ecrou auto-freiné M2,5 (10)	Dado Nylock M2,5 (10)
VTR243003	Shock Pistons: GL	Kolbenplatten: GL	Pistons d'amortisseurs: GL	Pistoni ammortizzatori: GL
VTR236104	2.5mm x 4.6mm x .5mm Washer (10)	2,5mm x 4,6mm x ,5mm Unterlegscheiben	Rondelle 2,5mm x 4,6mm x ,5mm	Rondella 2,5mm x 4,6mm x ,5mm
VTR243012	Shock Shaft, 3mm x 63mm (2)	Kolbenstange, 3mm x 63mm (2)	Tige d'amortisseurs 3x63mm (2): GL	Albero ammortizz. 3x63mm (2)
VTR243001	Rear Shock Body, Plastic: GL	Stoßdämpfergehäuse Kunststoff hinten: GL	Corps d'amortisseur arrière en plastique: GL	Corpo ammortizzatore posteriore plastica: GL
VTR243008	O-Ring, Shocks (8)	O-Ring / Dämpfer (8)	Joints toriques d'amortisseurs (8): GL	O-ring, ammortizz. (8)
VTR243004	Shock Bottom Cap, Plastic: GL	Dämpferkappen Oben / Kunststoff: GL	Bouchon inférieur d'amortisseur: GL	Tappo infer. ammortizzatore in plastica: GL
VTR243007	Shock Boots: GL	Staubschutzmanchetten Dämpfer: GL	Chaussettes d'amortisseurs (2): GL	Protezione ammortizz. : GL
VTR243014	Spring, Rear, 1,9: GL	Federsatz Hinten 1,9: GL	Ressorts arrière, dureté 1,9: GL	Molla poster. 1,9: GL

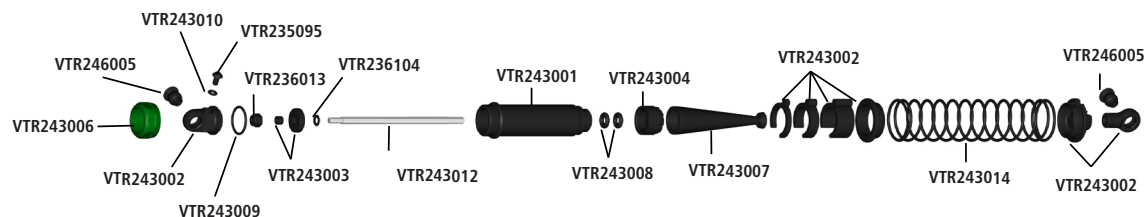

ROLLBAR ASSEMBLY // ÜBERROLLBÜGEL // ASSEMBLAGE DE L'ARCEAU // GRUPPO ROLLBAR //////////////////////////////////////

Part # Nummer Numéro Codice	Description	Beschreibung	Description	Descrizione
VTR235174	M3 x 6mm Flat Head Screw (10)	M3 x 6mm Flachkopfschrauben (10)	Vis à tête fraisée M3 x 6mm (10)	Viti a testa piatta M3 x 6mm (10)
VTR240005	Roof Plate: GL	Dachplatte: GL	Chapes de biellettes de direction 4,8mm: GL	Piastra protez.: GL
VTR240002	Main Roll Bar: GL	Vaterra Dämpferkappen Oben / Kunststoff	Barre de protection principale: GL	Roll bar principale:GL
VTR246000	Body Clips, Mini (10)	Karosseriekammern Mini (10):GL	Mini clips à carrosserie (10): GL	Clips mini per carrozzeria (10)
VTR240001	Light Buckets: GL	Stoßdämpfer Endkappe: GL	Cuvelages de phares: GL	Sedi fanali: GL

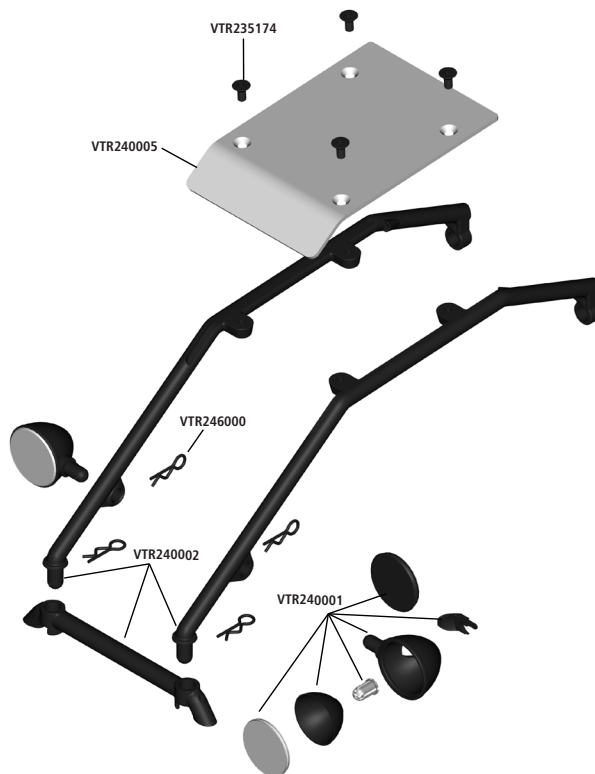

WING ASSEMBLY // FLÜGEL // ASSEMBLAGE DE L'AILERON // GRUPPO ALETTONE //////////////////////////////////////

Part # Nummer Numéro Codice	Description	Beschreibung	Description	Descrizione
VTR240004	Wing Set: GL	Kotflügelsatz: GL	Set d'ailerons: GL	Set alettone: GL
VTR240003	Wing Mounts: GL	Spoilerbefestigung	Supports d'aileron: GL	Supporti alettone: GL
VTR246000	Body Clips, Mini (10)	Karosseriekammern Mini (10):GL	Mini clips à carrosserie (10): GL	Clips mini per carrozzeria (10)
VTR240002	Main Roll Bar: GL	Vaterra Dämpferkappen Oben / Kunststoff	Barre de protection principale: GL	Roll bar principale:GL
VTR235222	M2,8 x 10mm Cap Head Screw Self Tapping (10)	M2,8 x 10mm Innensechskantschrauben selbstschneidene (10)	Vis à tête creuse auto-taraudeuses M2,8 x 10mm (10)	Viti a testa bombata autofilettanti M2,8 x 10mm (10)

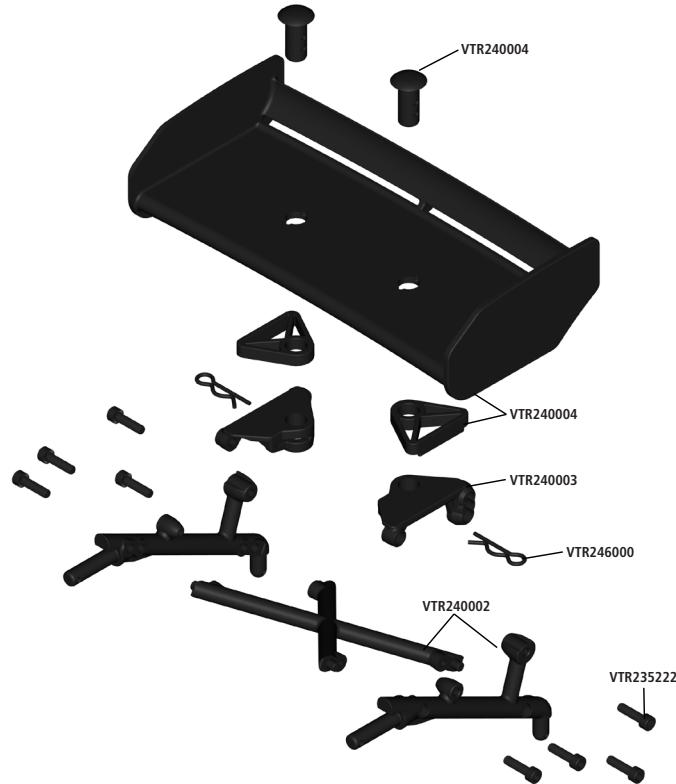

OPTIONAL PARTS // OPTIONALE BAUTEILE // PIÈCES OPTIONNELLES // PEZZI OPZIONALI //////////////////////////////////////

Part # Nummer Numéro Codice	Description	Beschreibung	Description	Descrizione
VTR343000	Front Aluminum Shock Set (2), 95mm	Aluminium Stoßdämpferset vorne (2) 95mm	Amortisseurs avant en aluminium (2), 95mm	Set ammortizz. anter. alluminio (2), 95mm
VTR343001	Rear Aluminum Shock Set (2), 114mm	Aluminium Stoßdämpferset hinten e (2) 114mm	Amortisseurs arrière en aluminium (2), 114mm	Set ammortizz. poster. alluminio (2), 114mm
VTR44005	Front Tire, Ribbed w/Foam, Soft, 40mm(2)	Reifen vorne m. Schaumeinlage, oft 40mm (2)	Pneus avant lignés avec insert, souple, 40mm (2)	Gomma anter., ribbed c/espanso, mor- bida, 40mm(2)
VTR44006	Rear Tire, Tetrapod w/Foam, Soft, 50mm (2)	Reifen hinten m. Schaumeinlage Soft 50mm (2)	Pneus arrière Tetrapod avec insert, souple, 50mm (2)	Gomma anter., tetrapod c/espanso, morbida, 50mm(2)
VTR344000	Sway Bar Set	Querstabilisator Set	Jeu de barres anti-roulis	Set barra oscillante
VTR340000	Light Set w/Buckets	Beleuchtung	Kit d'éclairage avec reflecteurs	Set luci c/Buckets
VTR340001	Body Kit, Clear	Body Kit , transparent	Carrosserie, transparente	Kit carrozzeria, trasparente



VATERRA™

It is a shared passion for motorsports and radio control. Extreme performance and extreme places. Cars and trucks that look and drive just like the real thing. Most of all, it is about gathering friends, grabbing a vehicle and having the time of your life.

Adventure Driven.™

